

DEALER		COLOURS INFORMATION For Office Use Only	
Dealer:		Order Date:	
Account: P.O.#:		S/N:	
Ordered By:			
Customer Name:			
Customer Weight:			

CHAIR INFORMATION	PRICE
ZEPHYR K0009	Base Wheel Chair Price K0009 \$ 4,900
Fixed FSH-RSH Max. Capacity 250Lbs	Total Section A \$
Main Frame: ZK55 & ZK60 High Grade A7000 Series Sport Chair	Total Section B \$
NOTE	Total Section C(Custom Parts Color) \$
	Total Section D \$
	Total Section E \$
	Total Section F \$
	ORDER GRAND TOTAL \$

A FRAME COLORS & PARTS COLORS

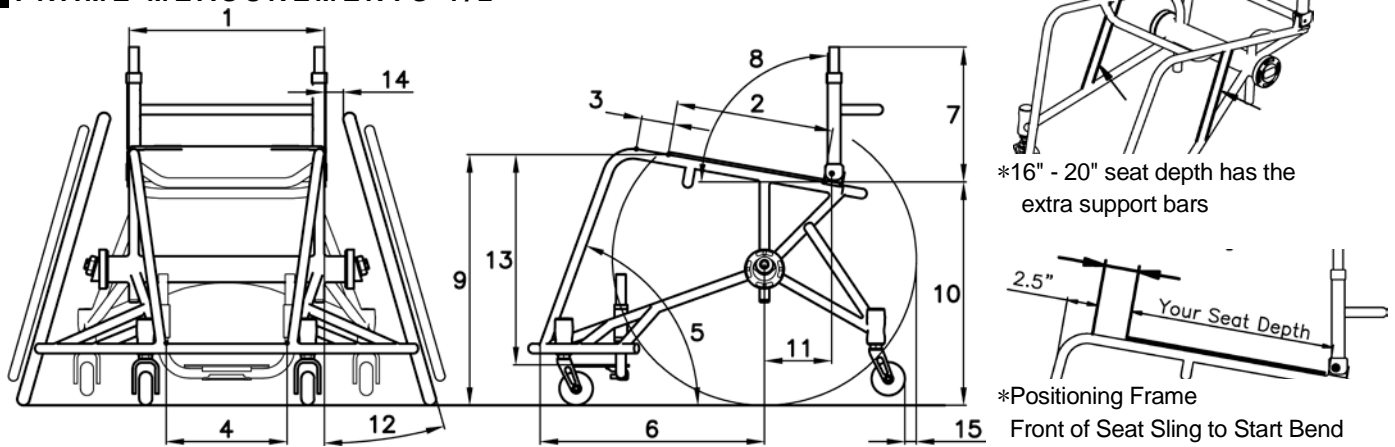

FRAME COLORS		
<input type="checkbox"/> Powder-Coated <input type="checkbox"/> Gloss Black <input type="checkbox"/> Twilight Flake <input type="checkbox"/> Yellow <input type="checkbox"/> Magenta <input type="checkbox"/> Fire Engine Red <input type="checkbox"/> White <input type="checkbox"/> Neon Yellow <input type="checkbox"/> Candy Blue <input type="checkbox"/> Candy Purple <input type="checkbox"/> Candy Green <input type="checkbox"/> Candy Red <input type="checkbox"/> Candy Raspberry <input type="checkbox"/> Cobalt Blue <input type="checkbox"/> Brass Metallic <input type="checkbox"/> Matte Gray <input type="checkbox"/> Matte Purple <input type="checkbox"/> Matte Blue <input type="checkbox"/> Matte Green <input type="checkbox"/> Matte Black <input type="checkbox"/> Matte Red <input type="checkbox"/> Tiffany Blue <input type="checkbox"/> Blue Lilac <input type="checkbox"/> Neon Green <input type="checkbox"/> Orange Sparkle <input type="checkbox"/> Mellon Yellow <input type="checkbox"/> Gun Smoke Silver <input type="checkbox"/> Shocker Yellow <input type="checkbox"/> Sparkle Burgundy <input type="checkbox"/> Granny Sparkle Green <input type="checkbox"/> Sparkle Sky Blue <input type="checkbox"/> Reed Green		STD
Special Colors	<input type="checkbox"/> Polished Aluminum- <input type="checkbox"/> 24 karat Gold	\$ 920 \$ CFP
PARTS COLORS (Custom Parts Color Section, Please see Section F)		
STD Color	Black Color (*Suspension Springs-Silver Color Only)-	\$ STD
Custom Color Main Bolt on Parts One Color Package	<input type="checkbox"/> Powder-Coated () . . . <input type="checkbox"/> Polished <input type="checkbox"/> 24 karat Gold Plated-	\$ 450 \$ 529 \$ CFP
Including: Backrest, Foot Plate, Forks & Knurl Nuts, Caps, Camber Discs - ☆marked parts		

B FRAME MEASUREMENTS 1/2

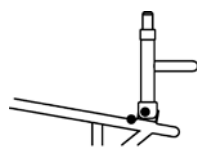
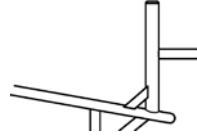
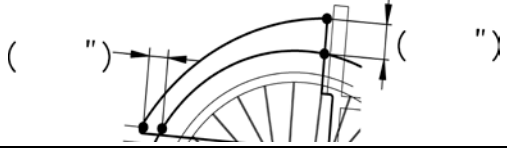
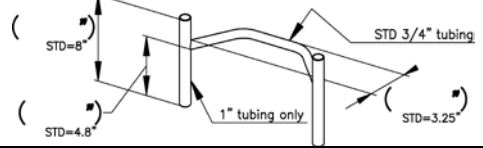

1	SEAT WIDTH	<input type="checkbox"/> 12.0" <input type="checkbox"/> 12.5" <input type="checkbox"/> 13.0" <input type="checkbox"/> 13.5" <input type="checkbox"/> 14.0" <input type="checkbox"/> 14.5" <input type="checkbox"/> 15.0" <input type="checkbox"/> 15.5" <input type="checkbox"/> 16.0" <input type="checkbox"/> 16.5" <input type="checkbox"/> 17.0" <input type="checkbox"/> 17.5" <input type="checkbox"/> 18.0" <input type="checkbox"/> 18.5" <input type="checkbox"/> 19.0"	\$ STD
2	SEAT DEPTH	<input type="checkbox"/> 12.0" <input type="checkbox"/> 13.0" <input type="checkbox"/> 14.0" <input type="checkbox"/> 15.0" <input type="checkbox"/> 16.0" <input type="checkbox"/> 17.0" <input type="checkbox"/> 18.0"	\$ STD
3	POSITIONING FRAME	<input type="checkbox"/> 0" (STD) <input type="checkbox"/> 1.0" <input type="checkbox"/> 2.0" <input type="checkbox"/> 3.0" <input type="checkbox"/> 4.0" <input type="checkbox"/> 5.0"	\$ STD
4	FOOTREST WIDTH	(")	\$ STD
	FOOT PLATE STYLE	<input type="checkbox"/> Adjustable Height Inside Footrest	\$ STD
		<input type="checkbox"/> Welded Tubular Footrest Width (") Depth (") Angle (") <input type="checkbox"/> Welded Tubular Footrest w/ABS Foot Plate (+\$138)	\$ 331
5 OR 6	FRAME ANGLE to the ground	<input type="checkbox"/> 65° <input type="checkbox"/> 70° <input type="checkbox"/> 75° <input type="checkbox"/> 80° <input type="checkbox"/> 85° <input type="checkbox"/> 90° Custom (°) to the ground	\$ STD
	FRONT FRAME LENGTH	(")	
	FRONT FRAME STYLE	<input type="checkbox"/> STD	\$ STD
		<input type="checkbox"/> w/WINGS	\$ 322
		<input type="checkbox"/> w/Basketball Roller (+\$ 72)	
NOTE			

B FRAME MEASUREMENTS 2/2

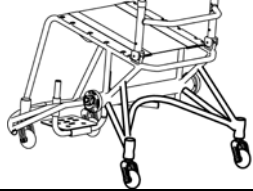
7	BACKREST HEIGHT	<input type="checkbox"/> 8"	<input type="checkbox"/> 9" <input type="checkbox"/> 10" <input type="checkbox"/> 11" <input type="checkbox"/> 12" Adj.Range	<input type="checkbox"/> 13" <input type="checkbox"/> 14" <input type="checkbox"/> 15" <input type="checkbox"/> 16" Adj.Range	<input type="checkbox"/> 17" <input type="checkbox"/> 18"	\$ STD	
	BACKREAT TYPE	<input type="checkbox"/> Folding with adjust height & angle					\$ STD
		<input type="checkbox"/> Welded Backrest *Non Folding /Non adjust. height & angle only					\$ 200
		<input type="checkbox"/> Welded Side Guards *Welded Backrest only					\$ 518
		<input type="checkbox"/> Custom Backrest *ie: double rigidizer bars, custom depth, Custom Height, etc					\$ 200
8	BACKREST ANGLE	Set at (°) to the ground *STD 90°				\$ STD	
9	FRONT SEAT HEIGHT	<input type="checkbox"/> 15.5" <input type="checkbox"/> 16.0" <input type="checkbox"/> 16.5" <input type="checkbox"/> 17.0" <input type="checkbox"/> 17.5" <input type="checkbox"/> 18.0" <input type="checkbox"/> 18.5" <input type="checkbox"/> 19.0" <input type="checkbox"/> 19.5" <input type="checkbox"/> 20.0" <input type="checkbox"/> 20.5" <input type="checkbox"/> 20 7/8"				\$ STD	
10	REAR SEAT HEIGHT	<input type="checkbox"/> 13.5" *24" wheels only <input type="checkbox"/> 14.0" *24", 25" wheels only <input type="checkbox"/> 14.5" *24", 25", 26" wheels only <input type="checkbox"/> 15.0" <input type="checkbox"/> 15.5" <input type="checkbox"/> 16.0" <input type="checkbox"/> 16.5" <input type="checkbox"/> 17.0" <input type="checkbox"/> 17.5" <input type="checkbox"/> 18.0" <input type="checkbox"/> 18.5" <input type="checkbox"/> 19.0" <input type="checkbox"/> 19.0" <input type="checkbox"/> 19.5" <input type="checkbox"/> 20.0" <input type="checkbox"/> 20.5" <input type="checkbox"/> 20 7/8"				\$ STD	
11	CENTER OF GRAVITY	<input type="checkbox"/> 2.5" <input type="checkbox"/> 3.0" <input type="checkbox"/> 3.5" <input type="checkbox"/> 4.0" <input type="checkbox"/> 4.5" <input type="checkbox"/> 5.0" <input type="checkbox"/> 5.5" <input type="checkbox"/> 6.0" <input type="checkbox"/> 6.5"				\$ STD	
12	CAMBER ANGLE	<input type="checkbox"/> 12° <input type="checkbox"/> 14° <input type="checkbox"/> 16° <input type="checkbox"/> 18° <input type="checkbox"/> 20°				\$ STD	
13	FRONT OF SEAT SLING TO FOOTREST	(") *Measure from the front edge of seat sling to top of footrest vertically.				\$ STD	
14	INSIDE WHEEL CLEARANCE	<input type="checkbox"/> 1/2" <input type="checkbox"/> 3/4" <input type="checkbox"/> 1.0" <input type="checkbox"/> 1 1/4" <input type="checkbox"/> 1 1/2" <input type="checkbox"/> 1 3/4" <input type="checkbox"/> 2.0"				\$ STD	
15	REAR CASTER TO REAR WHEELSPACING	<input type="checkbox"/> 0.5" (STD) Custom (") Available for Welded Wheelie Bar				\$ STD	
	REAR CASTER OPTION	<input type="checkbox"/> Omit Wheelie Bar				\$ STD	
		<input type="checkbox"/> Single Style Welded Wheelie Bar					\$ 290
		<input type="checkbox"/> Double Style Welded Wheelie Bar					\$ 543

Valid from 2023 Prices & Specifications Are Subject To Change Without Notice.

C SPECIAL PARTS COLORS (Please allow an additional 1-2 weeks delivery)

PARTS COLORS						
Powder-Coated	Gloss Black	Twilight Flake	Yellow	Magenta	Fire Engine Red	White
Neon Yellow	Candy Blue	Candy Purple	Candy Green	Candy Red	Candy Raspberry	Cobalt Blue
Brass Metal	Matte Gray	Matte Purple	Matte Blue	Matte Green	Matte Black	Matte Red
Sparkle Burgundy	Blue Lilac	Neon Green	Orange Sparkle	Mellon Yellow	Gun Smoke Silver	Shocker Yellow
Tiffany Blue	Granny Sparkle Green	Sparkle Sky Blue	Reed Green			
Special Colors	Polished Aluminum 24 karat Gold Plated					

Please Choose the Color for each Part

*Parts not selected will be black color. (Suspension Spring: Silver Color)

*Minimum 3 parts selected per order.

*PC=Powder-Coated

Backrest

- PC () \$173
- Polished \$259
- Gold Plated..... CFP

Camber Plates

- PC () \$90
- Polished \$100
- Gold Plated..... \$CFP

Caps

- PC () \$50
- Polished N/A
- Gold Plated..... N/A

Forks

- PC () \$90
- Polished \$104
- Gold Plated..... \$CFP

Foot Plate

- PC () \$70
- Polished \$104
- Gold Plated..... \$CFP

Caps

- PC () \$50
- Polished N/A
- Gold Plated..... N/A

Forks

- PC () \$90
- Polished \$104
- Gold Plated..... \$CFP

D COMPONENTS

SIDE GUARDS

Rigid Side Guards - Black ABS Non-Removable Removable Removable w/Hole **(\$14 up charge)** \$ 187

Size: STD Medium Cut to Wheel **(\$100 up charge)** Measurement

Color: Black Only

Rigid Side Guards - Aluminum Non-Removable Removable \$ 260

Size: Medium Only Cut to Wheel **(\$100 up charge)** Measurement

Color Black (STD) Pol. Aluminum (STD)

Powder Coated () **(\$140 up charge)**

Gold Plate **(+CFP)**

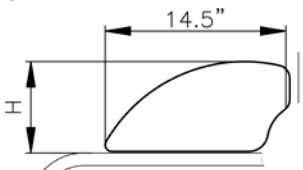

Height	Size
7.5"	STD
8.25"	Medium

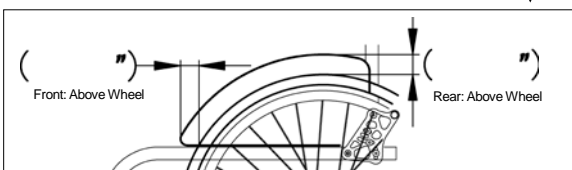

SEAT CUSHION

Foam Cushion w/Nylon Cover Thickness 1" 2" 3" 4" \$ CFP

Cushion Cover w/ Fun Fabric (Std. Foam Cushion Only)—Select Fabric () **(\$104 up charge)**

-*Please see section G for other cushion choices.-

MISCELLANEOUS

Frame Protectors / Black Leather/Zipper Type \$ 108

E0978 Seat Belt w/Auto Buckle Black Belt Only **E0978** \$ 113

Ratchet Strap Small Medium Large **Where on chair:** _____

\$ 288 \$ 288 \$ 311 ex: footplate, hips, knees, front legs.

UPHOLSTERY CHOICE & COLOR

Standard Adjustable Ht Backrest Black Only \$ STD

Adjustable Tension Backrest Black Only (*Not available with 8" Backrest Height) \$ 173

Options Fun Fabric: For Std. or Adj. Style

(Choose From Choices on Page 6 and write below) **(\$ 92 up charge)**

Backrest Leather Trim (outside panels) **(\$ up charge)** CFP

Calf Strap Black Matching Fabric **(\$65 up charge)** -Select Fabric () **K0038** \$ 35

Matching Fabric on Padded Side Guards -Select Fabric () \$ 278

NOTE

FABRIC CHOICE SHEET

1. Camouflage Girls

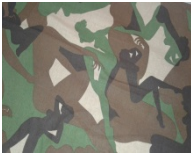

2. Purple Zebra



3. Silver Grey Snake

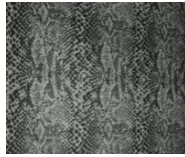

5. Laughing Skulls



6. Purple Snake



7. Sweetheart Pinup Girls



9. Blue Flames

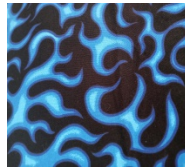

10. Arctic Camo



11. Furry Friends



12. Supercars



13. Urban Camo

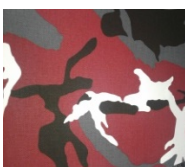

14. Superbikes



15. Sizzle Flames



16. Hot Rod Flames



17. Skulls w/ Attitude



18. Sweet Pink

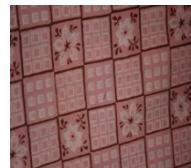

19. Heart and Soul



20. Home Run



21. Fuzzy Giraffe

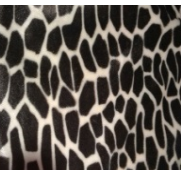

22. Cheetah



23. Paperweight Cobalt

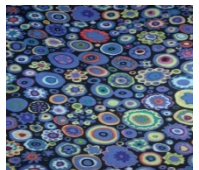

24. Zig Zag Dots



25. Smokey Tribal Flames

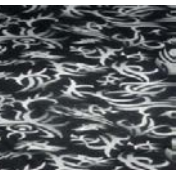

26. Rose and Rebellion



27. Tattoo Adventure(Cream

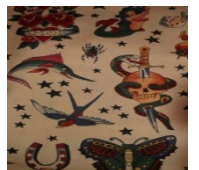

28. Red Tribal Flames

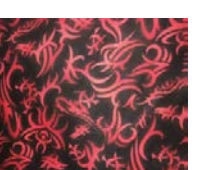

29. Tattoo Adventure(Black)

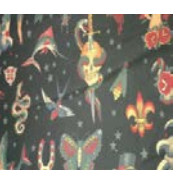

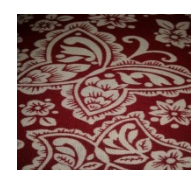

30. Butterfly Bandana

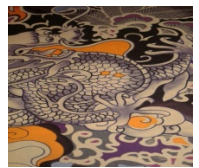

31. Tatsu Dragon



E WHEELS, TIRES, CASTERS, & FORKS

WHEELS																		
Wire Wheels	<input type="checkbox"/> 24" (540) <input type="checkbox"/> 25" (559) <input type="checkbox"/> 26" (590)		\$ NCO \$ NCO \$ NCO															
Spinergy Sport Spox 24 Spoke 	<input type="checkbox"/> 24" (540) <input type="checkbox"/> 25" (559) <input type="checkbox"/> 26" (590) <input type="checkbox"/> 27" (700C) 																	
	Spoke Color <input type="checkbox"/> Black With Silver Hub <input type="checkbox"/> Red With Black Hub <input type="checkbox"/> Yellow With Black Hub <input type="checkbox"/> Blue With Black Hub <input type="checkbox"/> White With Black Hub 		\$ 1,166															
	<input type="checkbox"/> Custom Color Spoke Pattern <table border="1" style="display: inline-table; margin-left: 10px;"> <thead> <tr> <th colspan="2"></th> <th>Left Wheel</th> <th>Right Wheel</th> </tr> </thead> <tbody> <tr> <td rowspan="2">Spokes Color</td> <td>Inside</td> <td></td> <td></td> </tr> <tr> <td>Outside</td> <td></td> <td></td> </tr> <tr> <td colspan="2">Hub Color</td> <td><input type="checkbox"/> Black/<input type="checkbox"/> Silver</td> <td><input type="checkbox"/> Black/<input type="checkbox"/> Silver</td> </tr> </tbody> </table>			Left Wheel	Right Wheel	Spokes Color	Inside			Outside			Hub Color		<input type="checkbox"/> Black/ <input type="checkbox"/> Silver	<input type="checkbox"/> Black/ <input type="checkbox"/> Silver		\$ 1,276
			Left Wheel	Right Wheel														
Spokes Color	Inside																	
	Outside																	
Hub Color		<input type="checkbox"/> Black/ <input type="checkbox"/> Silver	<input type="checkbox"/> Black/ <input type="checkbox"/> Silver															
Spinergy Sport Lite Extreme "SLX" 24 Spoke 	<input type="checkbox"/> 18 Spokes <input type="checkbox"/> 24 Spokes <input type="checkbox"/> 24" (540) <input type="checkbox"/> 25" (559) <input type="checkbox"/> 26" (590) <input type="checkbox"/> 27" (700C)																	
	Spoke Color <input type="checkbox"/> Black With Silver Hub <input type="checkbox"/> Red With Black Hub <input type="checkbox"/> Yellow With Black Hub <input type="checkbox"/> Blue With Black Hub <input type="checkbox"/> White With Black Hub <input type="checkbox"/> Neon Green With Black Hub <input type="checkbox"/> Pink With Black Hub <input type="checkbox"/> Orange With Black Hub <input type="checkbox"/> Purple With Black Hub		\$ 1,166															
	<input type="checkbox"/> Custom Color Spoke Pattern <table border="1" style="display: inline-table; margin-left: 10px;"> <thead> <tr> <th colspan="2"></th> <th>Left Wheel</th> <th>Right Wheel</th> </tr> </thead> <tbody> <tr> <td rowspan="2">Spokes Color</td> <td>Inside</td> <td></td> <td></td> </tr> <tr> <td>Outside</td> <td></td> <td></td> </tr> <tr> <td colspan="2">Hub Color</td> <td><input type="checkbox"/> Black/<input type="checkbox"/> Silver</td> <td><input type="checkbox"/> Black/<input type="checkbox"/> Silver</td> </tr> </tbody> </table>			Left Wheel	Right Wheel	Spokes Color	Inside			Outside			Hub Color		<input type="checkbox"/> Black/ <input type="checkbox"/> Silver	<input type="checkbox"/> Black/ <input type="checkbox"/> Silver		\$ 1,276
			Left Wheel	Right Wheel														
Spokes Color	Inside																	
	Outside																	
Hub Color		<input type="checkbox"/> Black/ <input type="checkbox"/> Silver	<input type="checkbox"/> Black/ <input type="checkbox"/> Silver															
HANDRIMS																		
Type	<input type="checkbox"/> Standard For 24", 25" or 26", 700C(27") Wheel Anodized Black		\$ STD															
	<input type="checkbox"/> Vinyl Coated For 24", 25", 26" Wheel		\$ 200															
	<input type="checkbox"/> Spinergy Silver Brushed For 24", 25", 26" Wheel		\$ 176															
	<input type="checkbox"/> The Q-Grip Handrims : anti-slip, latex-free, r * Not available with Y-360 Billet Wheels available with		\$ 543															
TAB LENGTH	<input type="checkbox"/> Long Tabs (STD inside clearance 3/4")		\$ STD															
	<input type="checkbox"/> Short Tabs (Inside clearance 1/2") *Not available with Natural Fit Handrim with thumb grip		\$ STD															
	<input type="checkbox"/> Short Tab (Set closest to wheel cut off excess)		\$ 35															
TIRES																		
<input type="checkbox"/> Primo High Pressure Tire <input type="checkbox"/> 24"x1", <input type="checkbox"/> 25"x1", <input type="checkbox"/> 26"x1", <input type="checkbox"/> 27" 700C Gray Tire with black wall Only E2211/E2212			\$ STD															
<input type="checkbox"/> Primo High Pressure Tire <input type="checkbox"/> 24"x1", <input type="checkbox"/> 25"x1" or <input type="checkbox"/> 26"x1" <input type="checkbox"/> Blue <input type="checkbox"/> Red E2211/E2212			\$ 100															
CASTERS																		
SIZE	TIRE WIDTH	HUB COLOR	TIRE COLOR	DESCRIPTION														
<input type="checkbox"/> 3"	1"	Black Hub	Black Tire Only	Polyurethane	\$ STD													
<input type="checkbox"/> 3"	1"	Plastic Black Hub	Clear Tire Only	Lighted, Polyurethane	\$ 86													
<input type="checkbox"/> 3"	1"	Red Hub	Red Tire Only	Polyurethane	\$ STD													
<input type="checkbox"/> 3"	1"	Black Hub	Clear Tire Only	Polyurethane	\$ STD													
<input type="checkbox"/> 3"	1"	Aluminum Silver Hub	Black Tire Only	Made By Frog Legs	\$ 209													
<input type="checkbox"/> 3"	1"	Aluminum Black Hub	Black Tire Only	Made By Frog Legs	\$ 209													
<input type="checkbox"/> 3"	1.5"	Aluminum Silver Hub	Black Tire Only	Soft Roll Made By Frog Legs	\$ 209													
<input type="checkbox"/> 3"	1.5"	Aluminum Black Hub	Black Tire Only	Soft Roll Made By Frog Legs	\$ 209													
<input type="checkbox"/> "	<input type="checkbox"/> 1" or <input type="checkbox"/> 1.5"	Hub Color:	Tread Color:	Soft Roll Made By Frog Legs	E2222 \$ CFP													
FORKS																		
<input type="checkbox"/> STD Aluminum Forks Black Only					\$ STD													

G CHAIR OPTIONS 1 / 2

SEAT CUSHION				
SUPRACOR® WHEELCHAIR CUSHIONS				
Stimulite® Contoured Cushion *Black Upholstery only *Comes with Zipper Pouch <input type="checkbox"/> Extra Sensitive (\$35 up charge) <input type="checkbox"/> Sling Style Bottom (\$52 up charge) <input type="checkbox"/> Custom Size (\$- CFP) W(") x D(") <input type="checkbox"/> Extra Cover (\$120 up charge)	<input type="checkbox"/> W14"xD16" (CD1416)	E2603 \$ 707	
	<input type="checkbox"/> W16"xD16" (CD1616)	E2603 \$ 707	
	<input type="checkbox"/> W16"xD18" (CD1618)	E2603 \$ 707	
	<input type="checkbox"/> W18"xD16" (CD1816)	E2603 \$ 707	
	<input type="checkbox"/> W18"xD18" (CD1818)	E2603 \$ 707	
	<input type="checkbox"/> W18"xD20" (CD1820)	E2603 \$ 714	
	<input type="checkbox"/> W20"xD16" (CD2016)	E2603 \$ 714	
	<input type="checkbox"/> W20"xD18" (CD2018)	E2603 \$ 714	
	<input type="checkbox"/> W20"xD20" (CD2020)	E2603 \$ 734	
	Stimulite® Slimline Cushion *Black Upholstery only <input type="checkbox"/> Extra Sensitive (\$35 up charge) <input type="checkbox"/> Sling Style Bottom (\$52 up charge) <input type="checkbox"/> Custom Size (\$- CFP) W(") x D(") <input type="checkbox"/> Extra Cover (\$86 up charge)	<input type="checkbox"/> W14"xD16" (SM1416)	E2603 \$ 446
<input type="checkbox"/> W16"xD16" (SM1616)		E2603 \$ 446	
<input type="checkbox"/> W16"xD18" (SM1618)		E2603 \$ 446	
<input type="checkbox"/> W18"xD18" (SM1818)		E2603 \$ 446	
<input type="checkbox"/> W18"xD20" (SM1820)		E2603 \$ 490	
<input type="checkbox"/> W20"xD16" (SM2016)		E2603 \$ 490	
<input type="checkbox"/> W20"xD18" (SM2018)		E2603 \$ 490	
<input type="checkbox"/> W20"xD20" (SM2020)		E2603 \$ 518	
Stimulite® Corbee Pediatric *Black Upholstery only <input type="checkbox"/> Extra Cover (\$86 up charge)	<input type="checkbox"/> W10"xD10" (PD1010)	E2603 \$ 342	
	<input type="checkbox"/> W12"xD12" (PD1212)	E2603 \$ 342	
	<input type="checkbox"/> W14"xD14" (PD1414)	E2603 \$ 342	
	<input type="checkbox"/> Extra Sensitive (\$35 up charge) <input type="checkbox"/> Sling Style Bottom (\$52 up charge) <input type="checkbox"/> Custom Size W(") x D(") (\$- CFP)			
ROHO WHEELCHAIR CUSHIONS				
Choose Size	<input type="checkbox"/> 4" HIGH PROFILE® QUADTRO SELECT® CUSHION *Black Upholstery		<input type="checkbox"/> Extra Cover (\$+100) only	E2622-2623 \$ 669
	<input type="checkbox"/> W12"xD12"	<input type="checkbox"/> W12"xD13"	<input type="checkbox"/> W13"xD13"	<input type="checkbox"/> W13"xD15"
	<input type="checkbox"/> W15"xD16"	<input type="checkbox"/> W15"xD18"	<input type="checkbox"/> W16"xD15"	<input type="checkbox"/> W16"xD16"
	<input type="checkbox"/> W18"xD16"	<input type="checkbox"/> W18"xD18"	<input type="checkbox"/> W18"xD20"	<input type="checkbox"/> W18"xD22"
	<input type="checkbox"/> W20"xD22"	<input type="checkbox"/> W22"xD18"	<input type="checkbox"/> W22"xD20"	<input type="checkbox"/> W22"xD22"
		<input type="checkbox"/> Custom Size W(") x D(") (\$+CFP)		
Choose Size	<input type="checkbox"/> 3" MID PROFILE® QUADTRO SELECT® CUSHION *Black Upholstery only		<input type="checkbox"/> Extra Cover (\$+100)	E2622-2623 \$ 669
	<input type="checkbox"/> W15"xD15"	<input type="checkbox"/> W15"xD16"	<input type="checkbox"/> W16"xD16"	<input type="checkbox"/> W16"xD18"
			<input type="checkbox"/> W18"xD16"	<input type="checkbox"/> W18"xD18"
		<input type="checkbox"/> Custom Size W(") x D(") (\$+CFP)		
Choose Size	<input type="checkbox"/> 2" LOW PROFILE® QUADTRO SELECT® CUSHION *Black Upholstery only		<input type="checkbox"/> Extra Cover (\$+100)	E2622-2623 \$ 669
	<input type="checkbox"/> W12"xD12"	<input type="checkbox"/> W12"xD13"	<input type="checkbox"/> W13"xD13"	<input type="checkbox"/> W13"xD15"
	<input type="checkbox"/> W15"xD16"	<input type="checkbox"/> W15"xD18"	<input type="checkbox"/> W16"xD15"	<input type="checkbox"/> W16"xD16"
	<input type="checkbox"/> W18"xD16"	<input type="checkbox"/> W18"xD18"	<input type="checkbox"/> W18"xD20"	<input type="checkbox"/> W20"xD16"
			<input type="checkbox"/> W20"xD18"	<input type="checkbox"/> W20"xD20"
		<input type="checkbox"/> Custom Size W(") x D(") (\$+CFP)		
THE CURVE CUSHION *Black Upholstery only <input type="checkbox"/> Extra Cover (\$+ 46	<input type="checkbox"/> W10"xD10"	<input type="checkbox"/> W10"xD11"	<input type="checkbox"/> W10"xD11"	<input type="checkbox"/> W10"xD12"
	<input type="checkbox"/> W12"xD13"	<input type="checkbox"/> W12"xD14"	<input type="checkbox"/> W13"xD11"	<input type="checkbox"/> W13"xD12"
	<input type="checkbox"/> W14"xD14"	<input type="checkbox"/> W14"xD15"	<input type="checkbox"/> W14"xD16"	<input type="checkbox"/> W15"xD14"
	<input type="checkbox"/> W16"xD14"	<input type="checkbox"/> W16"xD15"	<input type="checkbox"/> W16"xD16"	<input type="checkbox"/> W16"xD17"
	<input type="checkbox"/> W17"xD17"	<input type="checkbox"/> W17"xD18"	<input type="checkbox"/> W18"xD16"	<input type="checkbox"/> W18"xD17"
		<input type="checkbox"/> W11"xD12"	<input type="checkbox"/> W12"xD12"	
		<input type="checkbox"/> W13"xD13"	<input type="checkbox"/> W13"xD14"	
		<input type="checkbox"/> W15"xD15"	<input type="checkbox"/> W15"xD16"	
		<input type="checkbox"/> W16"xD18"	<input type="checkbox"/> W17"xD16"	
		<input type="checkbox"/> W16"xD18"	<input type="checkbox"/> W18"xD18"	

G CHAIR OPTIONS 2 / 3

SEAT CUSHION			
Exgel Kaji Cushion			
For Comfortable Sitting To Prevent Pressure Sores			
<input type="checkbox"/> Owl Regular(1.6" Thick) Incontinence Cover Only	<input type="checkbox"/> W14"xD16" <input type="checkbox"/> W15"xD16" <input type="checkbox"/> W16"xD16" <input type="checkbox"/> W18"xD16"	<input type="checkbox"/> Extra Cover \$104 * No Custom Sizes	E2603 \$ 362 E2603 \$ 362 E2603 \$ 362 E2603 \$ 408
<input type="checkbox"/> Owl High(3.1" Thick) Incontinence Cover Only	<input type="checkbox"/> W14"xD16" <input type="checkbox"/> W15"xD16" <input type="checkbox"/> W16"xD16" <input type="checkbox"/> W18"xD16" <input type="checkbox"/> W18"xD18"	<input type="checkbox"/> Extra Cover \$104 * No Custom Sizes	E2603 \$ 437 E2603 \$ 437 E2603 \$ 437 E2603 \$ 495 E2603 \$ 495
<input type="checkbox"/> Owl Contour(3.0" Thick) Incontinence Cover Only	<input type="checkbox"/> W14"xD16" <input type="checkbox"/> W15"xD16" <input type="checkbox"/> W16"xD16" <input type="checkbox"/> W18"xD16"	<input type="checkbox"/> Extra Cover \$104 * No Custom Sizes	E2603 \$ 454 E2603 \$ 454 E2603 \$ 454 E2603 \$ 495
<input type="checkbox"/> Owl Deep Contour(4.3" Thick) <input type="checkbox"/> W14"xD16" \$518 <input type="checkbox"/> W15"xD16" \$518 <input type="checkbox"/> W16"xD16" \$518 <input type="checkbox"/> W18"xD16" \$558		<input type="checkbox"/> Extra Cover \$104 * No Custom Sizes- Incontinence Cover Only	
<input type="checkbox"/> Standard Regular(1.4" Thick) Easy to Use Flat Style (superior pressure redistribution)		<input type="checkbox"/> Extra Cover \$104 * No Custom Sizes- Incontinence Cover Only	E2622-2623
<input type="checkbox"/> W12" x D12" \$368 <input type="checkbox"/> W13" x D13" \$368 <input type="checkbox"/> W14" x D14" \$368 <input type="checkbox"/> W14" x D16" \$368 <input type="checkbox"/> W16" x D16" \$368 <input type="checkbox"/> W16" x D17" \$368 <input type="checkbox"/> W17" x D16" \$368 <input type="checkbox"/> W17" x D17" \$368 <input type="checkbox"/> W18" x D16" \$391 <input type="checkbox"/> W18" x D18" \$391 <input type="checkbox"/> W18" x D19" \$440 <input type="checkbox"/> W18" x D20" \$440 <input type="checkbox"/> W19" x D19" \$440		<input type="checkbox"/> Extra Cover \$104 * No Custom Sizes- Incontinence Cover Only	
<input type="checkbox"/> Standard High(2.6" Thick) Incontinence Cover Only *Black Upholstery only	<input type="checkbox"/> W12" x D12" \$383 <input type="checkbox"/> W13" x D13" \$ 383 <input type="checkbox"/> W14" x D14" \$383 <input type="checkbox"/> W14" x D16" \$ 383 <input type="checkbox"/> W16" x D16" \$383 <input type="checkbox"/> W16" x D17" \$383 <input type="checkbox"/> W17" x D16" \$383 <input type="checkbox"/> W17" x D17" \$383 <input type="checkbox"/> W18" x D16" \$460 <input type="checkbox"/> W18" x D18" \$460 <input type="checkbox"/> W18" x D19" \$512 <input type="checkbox"/> W18" x D20" \$512 <input type="checkbox"/> W19" x D19" \$512 <input type="checkbox"/> W18" x D19" \$512	<input type="checkbox"/> Extra Cover \$104	E2622
<input type="checkbox"/> Standard Anti-Thrust(2.6" Thick) * No Custom Sizes Incontinence Cover Only	<input type="checkbox"/> W16 x D16 \$460 <input type="checkbox"/> W18 x D16 \$500 <input type="checkbox"/> W18 x D18 \$500	Prevents Unwanted Forward Movement of lower back and hip bone <input type="checkbox"/> Extra Cover \$104	
<input type="checkbox"/> Lite Regular(2.2" Thick)	<input type="checkbox"/> W16" x D16" \$374 <input type="checkbox"/> W18" x D16" \$397 <input type="checkbox"/> W18" x D18" \$397	* No Custom Sizes- Incontinence Cover Only <input type="checkbox"/> Extra Cover \$104	
<input type="checkbox"/> Lite High(3.0" Thick)	<input type="checkbox"/> W16" x D16" \$408 <input type="checkbox"/> W18" x D16" \$431 <input type="checkbox"/> W18" x D18" \$431	* No Custom Sizes- Incontinence Cover Only <input type="checkbox"/> Extra Cover \$104	