

SABER-JR

Tel: 951-808-9131 FAX: 951-808-9949
Toll Free: 800-892-8998 www.colourswheelchair.com

DEALER		COLOURS INFORMATION For Office Use Only	
Dealer:		Order Date:	S/N:
Account:	P.O.#:		
Ordered By:			
Customer Name:			
Customer Weight:			

CHAIR INFORMATION	PRICE
SABER-JR E1235	Base Wheel Chair Price E1235 \$ 2,700
Adjustable FSH-RSH	Total Section A \$
Max. Capacity 250Lbs	Total Section B \$
NOTE	Total Section C(Custom Parts Color) \$
Saber JR is the economical solution when you want to grow your Chair by changing the seat depth and width after ordering.	Total Section D \$
Main Frame : ZK55 & ZK60 High Grade A7000 Series Aluminum	Total Section E \$
	Total Section F \$
	Total Section G \$
	Total Section H \$
Main Frame : Lifetime Warranty (5 YEARS)	ORDER GRAND TOTAL \$

A FRAME COLORS & PARTS COLORS

FRAME COLORS		
Powder-Coate	<input type="checkbox"/> Gloss Black <input type="checkbox"/> Twilight Flake <input type="checkbox"/> Yellow <input type="checkbox"/> Magenta <input type="checkbox"/> Fire Engine Red <input type="checkbox"/> White <input type="checkbox"/> Neon Yellow <input type="checkbox"/> Candy Blue <input type="checkbox"/> Candy Purple <input type="checkbox"/> Candy Green <input type="checkbox"/> Candy Red <input type="checkbox"/> Candy Raspberry <input type="checkbox"/> Cobalt Blue <input type="checkbox"/> Brass Metallic <input type="checkbox"/> Matte Gray <input type="checkbox"/> Matte Purple <input type="checkbox"/> Matte Blue <input type="checkbox"/> Matte Green <input type="checkbox"/> Matte Black <input type="checkbox"/> Matte Red <input type="checkbox"/> Tiffany Blue <input type="checkbox"/> Blue Lilac <input type="checkbox"/> Neon Green <input type="checkbox"/> Orange Sparkle <input type="checkbox"/> Mellon Yellow <input type="checkbox"/> Gun Smoke Silver <input type="checkbox"/> Shocker Yellow <input type="checkbox"/> Sparkle <input type="checkbox"/> Burgundy <input type="checkbox"/> Granny Sparkle Green <input type="checkbox"/> Sparkle Sky Blue <input type="checkbox"/> Reed Green	\$ STD
Special Colors	<input type="checkbox"/> Polished <input type="checkbox"/> 24 karat Gold Plated	\$ 920 \$ CFP
PARTS COLORS		
STD Color	Black Color (*Suspension Springs-Silver Color Only)-	\$ STD
Custom Color Main Bolt on Parts One Color Package	Including: Backrest, Foot Plate, Footrest Rings, Backrest Brackets, Saddle Stops Forks & Knurl Nuts, Caps, Front Suspension Springs, Axle Tube, Axle Clamps, Axle Plates, Axle Bases, Camber Discs ☆marked parts	<input type="checkbox"/> Powder-Coated () \$ 690 <input type="checkbox"/> Polished \$ 863 <input type="checkbox"/> 24 karat Gold Plated \$ CFP

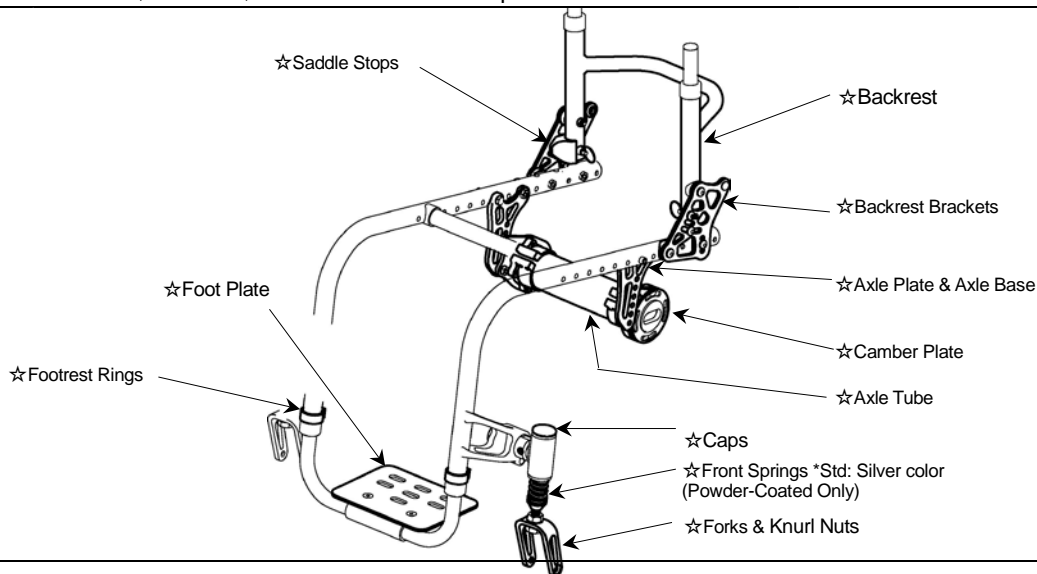

B FRAME MEASUREMENTS 1/2

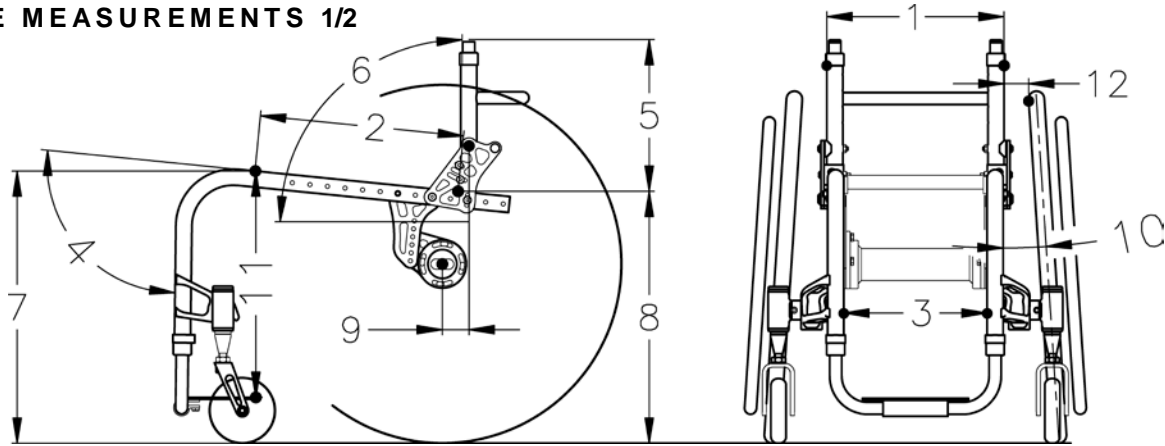

1. SEAT WIDTH	<input type="checkbox"/> 10" <input type="checkbox"/> 11" <input type="checkbox"/> 12" <input type="checkbox"/> 13" <input type="checkbox"/> 14" <input type="checkbox"/> 15" 	\$ STD
----------------------	--	--------

2. SEAT DEPTH	Depth Adj. Frame	<input type="checkbox"/> STD. Frame (13" Depth) Set at <input type="checkbox"/> 9" <input type="checkbox"/> 10" <input type="checkbox"/> 11" <input type="checkbox"/> 12" <input type="checkbox"/> 13" ..	\$ STD
		<input type="checkbox"/> Long. Frame (16" Depth) Set at <input type="checkbox"/> 12" <input type="checkbox"/> 13" <input type="checkbox"/> 14" <input type="checkbox"/> 15" <input type="checkbox"/> 16" ..	\$ STD

3. FOOTREST WIDTH	<input type="checkbox"/> STD (Seat Width Minus 2", No Taper Frame)	\$ STD
--------------------------	--	--------

*No Custom Modifications

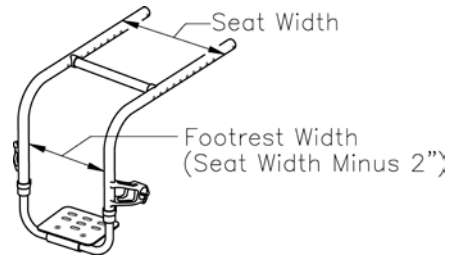

FOOT PLATE STYLE	<input type="checkbox"/> Standard single loop with adjust. height & angle. STD Foot Plate K0040	\$ STD
	<input type="checkbox"/> Single Flip-Back-single loop (no riser avail) with adjust. height & angle. STD Foot Plate K0040	\$ 173

Add Anti-Skid Tape (\$20 up charge)

STD Foot Plate Size Chart

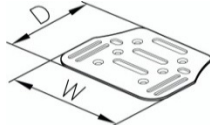

Your Seat Width	Foot Plate Size
10"-12"	W6.5"xD5"
13"-15"	W8.5"xD6.5"

*No Custom Modifications

4. FRAME BEND ANGLE	<input type="checkbox"/> 95° only	\$ STD
----------------------------	---	--------

*No Custom Modifications

FRAME ANGLE to the Ground

		Your Seat Depth							
		9"	10"	11"	12"	13"	14"	15"	16"
Seat Bucket	0"	95°	95°	95°	95°	95°	95°	95°	95°
	1"	89°	89°	90°	90°	91°	91°	91°	91°
	2"	82°	83°	85°	85°	86°	87°	87°	88°
	3"	76°	78°	79°	81°	82°	83°	83°	84°
	4"	/	/	74°	76°	77°	78°	80°	81°
	5"	/	/	/	70°	72°	74°	76°	77°

B FRAME MEASUREMENTS 2/2

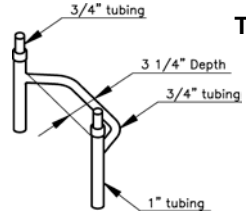
5. BACKREST HEIGHT <small>* Rigidizer bar 3.25" deep std.</small>	<input type="checkbox"/> 8" <input type="checkbox"/> 9" <input type="checkbox"/> 10" <input type="checkbox"/> 11" <input type="checkbox"/> 12" <input type="checkbox"/> 13" <input type="checkbox"/> 14" <input type="checkbox"/> 15" <input type="checkbox"/> 16" <input type="checkbox"/> 17" <input type="checkbox"/> 18"	Adj. Range Adj. Range Adj. Range	\$ STD																																																																																																																																																																																																																																																				
 <p>Type</p> <input type="checkbox"/> Locking mechanism with adjust. height & angle \$ STD <input type="checkbox"/> Double Locking mechanism with adjust. height & angle \$ 40 <input type="checkbox"/> Folding with adjust. height & angle \$ NCO *No Custom Modifications																																																																																																																																																																																																																																																							
	6. BACKREST ANGLE Set at (°) to the ground *STD 90° .			\$ STD																																																																																																																																																																																																																																																			
	7. FRONT SEAT HEIGHT <input type="checkbox"/> 14.5" <input type="checkbox"/> 15.0" <input type="checkbox"/> 15.5" <input type="checkbox"/> 16.0" <input type="checkbox"/> 16.5" <input type="checkbox"/> 17.0" <input type="checkbox"/> 17.5" <input type="checkbox"/> 18.0" <input type="checkbox"/> 18.5"			\$ STD																																																																																																																																																																																																																																																			
STD Front Seat Height Ranges *No Custom Modifications *Not Available with Quick Release Caster Axle.	The front seat heights are impacted by the size of your front caster.																																																																																																																																																																																																																																																						
	<table border="1" style="width:100%; border-collapse: collapse; text-align: center;"> <thead> <tr> <th colspan="2" rowspan="2"></th> <th colspan="10">Front Seat Height</th> </tr> <tr> <th>14.5"</th><th>15.0"</th><th>15.5"</th><th>16.0"</th><th>16.5"</th><th>17.0"</th><th>17.5"</th><th>18.0"</th><th>18.5"</th> </tr> </thead> <tbody> <tr> <td rowspan="8" style="writing-mode: vertical-rl; transform: rotate(180deg);">Your Casters & Forks</td> <td>3"Caster & STD Forks</td> <td><input type="checkbox"/>*</td><td><input type="checkbox"/></td><td><input type="checkbox"/></td><td><input type="checkbox"/></td><td><input type="checkbox"/></td><td><input type="checkbox"/></td><td><input type="checkbox"/></td><td><input type="checkbox"/></td><td><input type="checkbox"/></td><td><input type="checkbox"/></td> </tr> <tr> <td>3"Caster & Springs</td> <td><input type="checkbox"/>*</td><td><input type="checkbox"/></td><td><input type="checkbox"/></td><td><input type="checkbox"/></td><td><input type="checkbox"/></td><td><input type="checkbox"/></td><td><input type="checkbox"/></td><td><input type="checkbox"/></td><td><input type="checkbox"/></td><td><input type="checkbox"/></td> </tr> <tr> <td>3"Caster & Frog Legs</td> <td></td><td></td><td><input type="checkbox"/>*</td><td><input type="checkbox"/>*</td><td><input type="checkbox"/>*</td><td><input type="checkbox"/>*</td><td><input type="checkbox"/>*</td><td><input type="checkbox"/>*</td><td></td><td></td> </tr> <tr> <td>4"Caster & STD Forks</td> <td><input type="checkbox"/>*</td><td><input type="checkbox"/></td><td><input type="checkbox"/></td><td><input type="checkbox"/></td><td><input type="checkbox"/></td><td><input type="checkbox"/></td><td><input type="checkbox"/></td><td><input type="checkbox"/></td><td><input type="checkbox"/></td><td><input type="checkbox"/></td> </tr> <tr> <td>4"Caster & Springs</td> <td></td><td></td><td><input type="checkbox"/></td><td><input type="checkbox"/></td><td><input type="checkbox"/></td><td><input type="checkbox"/></td><td><input type="checkbox"/></td><td><input type="checkbox"/></td><td><input type="checkbox"/></td><td><input type="checkbox"/></td> </tr> <tr> <td>4"Caster & Frog Legs</td> <td></td><td></td><td><input type="checkbox"/>*</td><td><input type="checkbox"/>*</td><td><input type="checkbox"/>*</td><td><input type="checkbox"/>*</td><td><input type="checkbox"/>*</td><td><input type="checkbox"/>*</td><td><input type="checkbox"/>*</td><td><input type="checkbox"/>*</td> </tr> <tr> <td>5"Caster & STD Forks</td> <td></td><td><input type="checkbox"/>*</td><td><input type="checkbox"/>*</td><td><input type="checkbox"/>*</td><td><input type="checkbox"/>*</td><td><input type="checkbox"/>*</td><td><input type="checkbox"/>*</td><td><input type="checkbox"/>*</td><td><input type="checkbox"/>*</td><td><input type="checkbox"/>*</td> </tr> <tr> <td>5"Caster & Springs</td> <td></td><td></td><td></td><td><input type="checkbox"/>*</td><td><input type="checkbox"/>*</td><td><input type="checkbox"/>*</td><td><input type="checkbox"/>*</td><td><input type="checkbox"/>*</td><td><input type="checkbox"/>*</td><td><input type="checkbox"/>*</td> </tr> <tr> <td></td> <td>5"Caster & Frog Legs</td> <td></td><td></td><td></td><td></td><td><input type="checkbox"/>*</td><td><input type="checkbox"/>*</td><td><input type="checkbox"/>*</td><td><input type="checkbox"/>*</td><td><input type="checkbox"/>*</td> </tr> </tbody> </table>												Front Seat Height										14.5"	15.0"	15.5"	16.0"	16.5"	17.0"	17.5"	18.0"	18.5"	Your Casters & Forks	3"Caster & STD Forks	<input type="checkbox"/> *	<input type="checkbox"/>	<input type="checkbox"/>	<input type="checkbox"/>	<input type="checkbox"/>	<input type="checkbox"/>	<input type="checkbox"/>	<input type="checkbox"/>	<input type="checkbox"/>	<input type="checkbox"/>	3"Caster & Springs	<input type="checkbox"/> *	<input type="checkbox"/>	<input type="checkbox"/>	<input type="checkbox"/>	<input type="checkbox"/>	<input type="checkbox"/>	<input type="checkbox"/>	<input type="checkbox"/>	<input type="checkbox"/>	<input type="checkbox"/>	3"Caster & Frog Legs			<input type="checkbox"/> *	<input type="checkbox"/> *	<input type="checkbox"/> *	<input type="checkbox"/> *	<input type="checkbox"/> *	<input type="checkbox"/> *			4"Caster & STD Forks	<input type="checkbox"/> *	<input type="checkbox"/>	<input type="checkbox"/>	<input type="checkbox"/>	<input type="checkbox"/>	<input type="checkbox"/>	<input type="checkbox"/>	<input type="checkbox"/>	<input type="checkbox"/>	<input type="checkbox"/>	4"Caster & Springs			<input type="checkbox"/>	<input type="checkbox"/>	<input type="checkbox"/>	<input type="checkbox"/>	<input type="checkbox"/>	<input type="checkbox"/>	<input type="checkbox"/>	<input type="checkbox"/>	4"Caster & Frog Legs			<input type="checkbox"/> *	<input type="checkbox"/> *	<input type="checkbox"/> *	<input type="checkbox"/> *	<input type="checkbox"/> *	<input type="checkbox"/> *	<input type="checkbox"/> *	<input type="checkbox"/> *	5"Caster & STD Forks		<input type="checkbox"/> *	<input type="checkbox"/> *	<input type="checkbox"/> *	<input type="checkbox"/> *	<input type="checkbox"/> *	<input type="checkbox"/> *	<input type="checkbox"/> *	<input type="checkbox"/> *	<input type="checkbox"/> *	5"Caster & Springs				<input type="checkbox"/> *	<input type="checkbox"/> *	<input type="checkbox"/> *	<input type="checkbox"/> *	<input type="checkbox"/> *	<input type="checkbox"/> *	<input type="checkbox"/> *		5"Caster & Frog Legs					<input type="checkbox"/> *	<input type="checkbox"/> *	<input type="checkbox"/> *	<input type="checkbox"/> *	<input type="checkbox"/> *																																																																																																																				
		Front Seat Height																																																																																																																																																																																																																																																					
		14.5"	15.0"	15.5"	16.0"	16.5"	17.0"	17.5"	18.0"	18.5"																																																																																																																																																																																																																																													
Your Casters & Forks	3"Caster & STD Forks	<input type="checkbox"/> *	<input type="checkbox"/>	<input type="checkbox"/>	<input type="checkbox"/>	<input type="checkbox"/>	<input type="checkbox"/>	<input type="checkbox"/>	<input type="checkbox"/>	<input type="checkbox"/>	<input type="checkbox"/>																																																																																																																																																																																																																																												
	3"Caster & Springs	<input type="checkbox"/> *	<input type="checkbox"/>	<input type="checkbox"/>	<input type="checkbox"/>	<input type="checkbox"/>	<input type="checkbox"/>	<input type="checkbox"/>	<input type="checkbox"/>	<input type="checkbox"/>	<input type="checkbox"/>																																																																																																																																																																																																																																												
	3"Caster & Frog Legs			<input type="checkbox"/> *	<input type="checkbox"/> *	<input type="checkbox"/> *	<input type="checkbox"/> *	<input type="checkbox"/> *	<input type="checkbox"/> *																																																																																																																																																																																																																																														
	4"Caster & STD Forks	<input type="checkbox"/> *	<input type="checkbox"/>	<input type="checkbox"/>	<input type="checkbox"/>	<input type="checkbox"/>	<input type="checkbox"/>	<input type="checkbox"/>	<input type="checkbox"/>	<input type="checkbox"/>	<input type="checkbox"/>																																																																																																																																																																																																																																												
	4"Caster & Springs			<input type="checkbox"/>	<input type="checkbox"/>	<input type="checkbox"/>	<input type="checkbox"/>	<input type="checkbox"/>	<input type="checkbox"/>	<input type="checkbox"/>	<input type="checkbox"/>																																																																																																																																																																																																																																												
	4"Caster & Frog Legs			<input type="checkbox"/> *	<input type="checkbox"/> *	<input type="checkbox"/> *	<input type="checkbox"/> *	<input type="checkbox"/> *	<input type="checkbox"/> *	<input type="checkbox"/> *	<input type="checkbox"/> *																																																																																																																																																																																																																																												
	5"Caster & STD Forks		<input type="checkbox"/> *	<input type="checkbox"/> *	<input type="checkbox"/> *	<input type="checkbox"/> *	<input type="checkbox"/> *	<input type="checkbox"/> *	<input type="checkbox"/> *	<input type="checkbox"/> *	<input type="checkbox"/> *																																																																																																																																																																																																																																												
	5"Caster & Springs				<input type="checkbox"/> *	<input type="checkbox"/> *	<input type="checkbox"/> *	<input type="checkbox"/> *	<input type="checkbox"/> *	<input type="checkbox"/> *	<input type="checkbox"/> *																																																																																																																																																																																																																																												
	5"Caster & Frog Legs					<input type="checkbox"/> *	<input type="checkbox"/> *	<input type="checkbox"/> *	<input type="checkbox"/> *	<input type="checkbox"/> *																																																																																																																																																																																																																																													
8. REAR SEAT HEIGHT <input type="checkbox"/> 12.5" <input type="checkbox"/> 13.0" <input type="checkbox"/> 13.5" <input type="checkbox"/> 14.0" <input type="checkbox"/> 14.5" <input type="checkbox"/> 15.0" <input type="checkbox"/> 15.5" <input type="checkbox"/> 16.0" <input type="checkbox"/> 16.5" <input type="checkbox"/> 17.0" <input type="checkbox"/> 17.5"			\$ STD																																																																																																																																																																																																																																																				
STD Rear Seat Height Ranges *No Custom Modifications		<table border="1" style="width:100%; border-collapse: collapse; text-align: center;"> <thead> <tr> <th>Rear Tire Size</th> <th>Rear Seat Height</th> </tr> </thead> <tbody> <tr> <td>20"x1"(451)</td> <td>12.5"- 16.0"</td> </tr> <tr> <td>20"x1 3/8"(451)</td> <td>13.0"- 16.5"</td> </tr> <tr> <td>22"x1"(501)</td> <td>13.5"- 17.0"</td> </tr> <tr> <td>22"x1 3/8"(501)</td> <td>14.0"- 17.5"</td> </tr> </tbody> </table>		Rear Tire Size	Rear Seat Height	20"x1"(451)	12.5"- 16.0"	20"x1 3/8"(451)	13.0"- 16.5"	22"x1"(501)	13.5"- 17.0"	22"x1 3/8"(501)	14.0"- 17.5"																																																																																																																																																																																																																																										
Rear Tire Size	Rear Seat Height																																																																																																																																																																																																																																																						
20"x1"(451)	12.5"- 16.0"																																																																																																																																																																																																																																																						
20"x1 3/8"(451)	13.0"- 16.5"																																																																																																																																																																																																																																																						
22"x1"(501)	13.5"- 17.0"																																																																																																																																																																																																																																																						
22"x1 3/8"(501)	14.0"- 17.5"																																																																																																																																																																																																																																																						
9. CENTER OF GRAVITY <input type="checkbox"/> -1.5" <input type="checkbox"/> -1.0" <input type="checkbox"/> -0.5" <input type="checkbox"/> 0" <input type="checkbox"/> 0.5" <input type="checkbox"/> 1.0" <input type="checkbox"/> 1.5" <input type="checkbox"/> 2.0" <input type="checkbox"/> 2.5" <input type="checkbox"/> 3.0" <input type="checkbox"/> 3.5"			\$ STD																																																																																																																																																																																																																																																				
Center of Gravity Ranges		<table border="1" style="width:100%; border-collapse: collapse; text-align: center;"> <thead> <tr> <th rowspan="2">Seat Depth Frame</th> <th rowspan="2">Wheel</th> <th colspan="12">Your Center of Gravity</th> </tr> <tr> <th>-1.5"</th><th>-1.0"</th><th>-0.5"</th><th>0"</th><th>0.5"</th><th>1.0"</th><th>1.5"</th><th>2.0"</th><th>2.5"</th><th>3.0"</th><th>3.5"</th> </tr> </thead> <tbody> <tr> <td rowspan="4" style="writing-mode: vertical-rl; transform: rotate(180deg);">STD Frame</td> <td>9" 20" wheel</td> <td><input type="checkbox"/></td><td><input type="checkbox"/></td><td><input type="checkbox"/>☆</td><td><input type="checkbox"/>☆</td><td></td><td></td><td></td><td></td><td></td><td></td><td></td><td></td> </tr> <tr> <td>9" 22" wheel</td> <td><input type="checkbox"/></td><td><input type="checkbox"/></td><td><input type="checkbox"/>☆</td><td></td><td></td><td></td><td></td><td></td><td></td><td></td><td></td><td></td> </tr> <tr> <td>10" 20" wheel</td> <td><input type="checkbox"/></td><td><input type="checkbox"/></td><td><input type="checkbox"/></td><td><input type="checkbox"/>☆</td><td><input type="checkbox"/>☆</td><td></td><td></td><td></td><td></td><td></td><td></td><td></td> </tr> <tr> <td>10" 22" wheel</td> <td><input type="checkbox"/></td><td><input type="checkbox"/></td><td><input type="checkbox"/></td><td><input type="checkbox"/>☆</td><td></td><td></td><td></td><td></td><td></td><td></td><td></td><td></td> </tr> <tr> <td rowspan="12" style="writing-mode: vertical-rl; transform: rotate(180deg);">Long Frame</td> <td>11" 20" wheel</td> <td></td><td><input type="checkbox"/></td><td><input type="checkbox"/></td><td><input type="checkbox"/></td><td><input type="checkbox"/></td><td><input type="checkbox"/></td><td><input type="checkbox"/></td><td><input type="checkbox"/>☆</td><td></td><td></td><td></td><td></td> </tr> <tr> <td>11" 22" wheel</td> <td></td><td><input type="checkbox"/></td><td><input type="checkbox"/></td><td><input type="checkbox"/></td><td><input type="checkbox"/></td><td><input type="checkbox"/></td><td><input type="checkbox"/></td><td></td><td></td><td></td><td></td><td></td> </tr> <tr> <td>12" 20" wheel</td> <td><input type="checkbox"/>★</td><td><input type="checkbox"/>★</td><td><input type="checkbox"/></td><td><input type="checkbox"/></td><td><input type="checkbox"/></td><td><input type="checkbox"/></td><td><input type="checkbox"/></td><td><input type="checkbox"/>☆</td><td></td><td></td><td></td><td></td> </tr> <tr> <td>12" 22" wheel</td> <td><input type="checkbox"/>★</td><td><input type="checkbox"/>★</td><td><input type="checkbox"/></td><td><input type="checkbox"/></td><td><input type="checkbox"/></td><td><input type="checkbox"/></td><td><input type="checkbox"/></td><td></td><td></td><td></td><td></td><td></td> </tr> <tr> <td>13" 20" wheel</td> <td><input type="checkbox"/>★</td><td><input type="checkbox"/>★</td><td><input type="checkbox"/>★</td><td><input type="checkbox"/></td><td><input type="checkbox"/></td><td><input type="checkbox"/></td><td><input type="checkbox"/></td><td><input type="checkbox"/></td><td><input type="checkbox"/></td><td><input type="checkbox"/></td><td><input type="checkbox"/></td><td></td> </tr> <tr> <td>13" 22" wheel</td> <td><input type="checkbox"/>★</td><td><input type="checkbox"/>★</td><td><input type="checkbox"/>★</td><td><input type="checkbox"/></td><td><input type="checkbox"/></td><td><input type="checkbox"/></td><td><input type="checkbox"/></td><td><input type="checkbox"/></td><td><input type="checkbox"/></td><td><input type="checkbox"/></td><td><input type="checkbox"/></td><td></td> </tr> <tr> <td>14" 20" wheel</td> <td></td><td><input type="checkbox"/></td><td><input type="checkbox"/></td><td><input type="checkbox"/></td><td><input type="checkbox"/></td><td><input type="checkbox"/></td><td><input type="checkbox"/></td><td><input type="checkbox"/></td><td><input type="checkbox"/></td><td><input type="checkbox"/></td><td><input type="checkbox"/></td><td><input type="checkbox"/></td> </tr> <tr> <td>14" 22" wheel</td> <td></td><td><input type="checkbox"/></td><td><input type="checkbox"/></td><td><input type="checkbox"/></td><td><input type="checkbox"/></td><td><input type="checkbox"/></td><td><input type="checkbox"/></td><td><input type="checkbox"/></td><td><input type="checkbox"/></td><td><input type="checkbox"/></td><td><input type="checkbox"/></td><td><input type="checkbox"/></td> </tr> <tr> <td>15" 20" wheel</td> <td></td><td></td><td><input type="checkbox"/></td><td><input type="checkbox"/></td><td><input type="checkbox"/></td><td><input type="checkbox"/></td><td><input type="checkbox"/></td><td><input type="checkbox"/></td><td><input type="checkbox"/></td><td><input type="checkbox"/></td><td><input type="checkbox"/></td><td><input type="checkbox"/></td> </tr> <tr> <td>15" 22" wheel</td> <td></td><td></td><td><input type="checkbox"/></td><td><input type="checkbox"/></td><td><input type="checkbox"/></td><td><input type="checkbox"/></td><td><input type="checkbox"/></td><td><input type="checkbox"/></td><td><input type="checkbox"/></td><td><input type="checkbox"/></td><td><input type="checkbox"/></td><td><input type="checkbox"/></td> </tr> <tr> <td>16" 20" wheel</td> <td></td><td></td><td><input type="checkbox"/></td><td><input type="checkbox"/></td><td><input type="checkbox"/></td><td><input type="checkbox"/></td><td><input type="checkbox"/></td><td><input type="checkbox"/></td><td><input type="checkbox"/></td><td><input type="checkbox"/></td><td><input type="checkbox"/></td><td><input type="checkbox"/></td> </tr> <tr> <td>16" 22" wheel</td> <td></td><td></td><td><input type="checkbox"/></td><td><input type="checkbox"/></td><td><input type="checkbox"/></td><td><input type="checkbox"/></td><td><input type="checkbox"/></td><td><input type="checkbox"/></td><td><input type="checkbox"/></td><td><input type="checkbox"/></td><td><input type="checkbox"/></td><td><input type="checkbox"/></td> </tr> </tbody> </table>										Seat Depth Frame	Wheel	Your Center of Gravity												-1.5"	-1.0"	-0.5"	0"	0.5"	1.0"	1.5"	2.0"	2.5"	3.0"	3.5"	STD Frame	9" 20" wheel	<input type="checkbox"/>	<input type="checkbox"/>	<input type="checkbox"/> ☆	<input type="checkbox"/> ☆									9" 22" wheel	<input type="checkbox"/>	<input type="checkbox"/>	<input type="checkbox"/> ☆										10" 20" wheel	<input type="checkbox"/>	<input type="checkbox"/>	<input type="checkbox"/>	<input type="checkbox"/> ☆	<input type="checkbox"/> ☆								10" 22" wheel	<input type="checkbox"/>	<input type="checkbox"/>	<input type="checkbox"/>	<input type="checkbox"/> ☆									Long Frame	11" 20" wheel		<input type="checkbox"/>	<input type="checkbox"/>	<input type="checkbox"/>	<input type="checkbox"/>	<input type="checkbox"/>	<input type="checkbox"/>	<input type="checkbox"/> ☆					11" 22" wheel		<input type="checkbox"/>	<input type="checkbox"/>	<input type="checkbox"/>	<input type="checkbox"/>	<input type="checkbox"/>	<input type="checkbox"/>						12" 20" wheel	<input type="checkbox"/> ★	<input type="checkbox"/> ★	<input type="checkbox"/>	<input type="checkbox"/>	<input type="checkbox"/>	<input type="checkbox"/>	<input type="checkbox"/>	<input type="checkbox"/> ☆					12" 22" wheel	<input type="checkbox"/> ★	<input type="checkbox"/> ★	<input type="checkbox"/>	<input type="checkbox"/>	<input type="checkbox"/>	<input type="checkbox"/>	<input type="checkbox"/>						13" 20" wheel	<input type="checkbox"/> ★	<input type="checkbox"/> ★	<input type="checkbox"/> ★	<input type="checkbox"/>	<input type="checkbox"/>	<input type="checkbox"/>	<input type="checkbox"/>	<input type="checkbox"/>	<input type="checkbox"/>	<input type="checkbox"/>	<input type="checkbox"/>		13" 22" wheel	<input type="checkbox"/> ★	<input type="checkbox"/> ★	<input type="checkbox"/> ★	<input type="checkbox"/>	<input type="checkbox"/>	<input type="checkbox"/>	<input type="checkbox"/>	<input type="checkbox"/>	<input type="checkbox"/>	<input type="checkbox"/>	<input type="checkbox"/>		14" 20" wheel		<input type="checkbox"/>	<input type="checkbox"/>	<input type="checkbox"/>	<input type="checkbox"/>	<input type="checkbox"/>	<input type="checkbox"/>	<input type="checkbox"/>	<input type="checkbox"/>	<input type="checkbox"/>	<input type="checkbox"/>	<input type="checkbox"/>	14" 22" wheel		<input type="checkbox"/>	<input type="checkbox"/>	<input type="checkbox"/>	<input type="checkbox"/>	<input type="checkbox"/>	<input type="checkbox"/>	<input type="checkbox"/>	<input type="checkbox"/>	<input type="checkbox"/>	<input type="checkbox"/>	<input type="checkbox"/>	15" 20" wheel			<input type="checkbox"/>	<input type="checkbox"/>	<input type="checkbox"/>	<input type="checkbox"/>	<input type="checkbox"/>	<input type="checkbox"/>	<input type="checkbox"/>	<input type="checkbox"/>	<input type="checkbox"/>	<input type="checkbox"/>	15" 22" wheel			<input type="checkbox"/>	<input type="checkbox"/>	<input type="checkbox"/>	<input type="checkbox"/>	<input type="checkbox"/>	<input type="checkbox"/>	<input type="checkbox"/>	<input type="checkbox"/>	<input type="checkbox"/>	<input type="checkbox"/>	16" 20" wheel			<input type="checkbox"/>	<input type="checkbox"/>	<input type="checkbox"/>	<input type="checkbox"/>	<input type="checkbox"/>	<input type="checkbox"/>	<input type="checkbox"/>	<input type="checkbox"/>	<input type="checkbox"/>	<input type="checkbox"/>	16" 22" wheel			<input type="checkbox"/>	<input type="checkbox"/>	<input type="checkbox"/>	<input type="checkbox"/>	<input type="checkbox"/>	<input type="checkbox"/>	<input type="checkbox"/>	<input type="checkbox"/>	<input type="checkbox"/>	<input type="checkbox"/>	
Seat Depth Frame	Wheel	Your Center of Gravity																																																																																																																																																																																																																																																					
		-1.5"	-1.0"	-0.5"	0"	0.5"	1.0"	1.5"	2.0"	2.5"	3.0"	3.5"																																																																																																																																																																																																																																											
STD Frame	9" 20" wheel	<input type="checkbox"/>	<input type="checkbox"/>	<input type="checkbox"/> ☆	<input type="checkbox"/> ☆																																																																																																																																																																																																																																																		
	9" 22" wheel	<input type="checkbox"/>	<input type="checkbox"/>	<input type="checkbox"/> ☆																																																																																																																																																																																																																																																			
	10" 20" wheel	<input type="checkbox"/>	<input type="checkbox"/>	<input type="checkbox"/>	<input type="checkbox"/> ☆	<input type="checkbox"/> ☆																																																																																																																																																																																																																																																	
	10" 22" wheel	<input type="checkbox"/>	<input type="checkbox"/>	<input type="checkbox"/>	<input type="checkbox"/> ☆																																																																																																																																																																																																																																																		
Long Frame	11" 20" wheel		<input type="checkbox"/>	<input type="checkbox"/>	<input type="checkbox"/>	<input type="checkbox"/>	<input type="checkbox"/>	<input type="checkbox"/>	<input type="checkbox"/> ☆																																																																																																																																																																																																																																														
	11" 22" wheel		<input type="checkbox"/>	<input type="checkbox"/>	<input type="checkbox"/>	<input type="checkbox"/>	<input type="checkbox"/>	<input type="checkbox"/>																																																																																																																																																																																																																																															
	12" 20" wheel	<input type="checkbox"/> ★	<input type="checkbox"/> ★	<input type="checkbox"/>	<input type="checkbox"/>	<input type="checkbox"/>	<input type="checkbox"/>	<input type="checkbox"/>	<input type="checkbox"/> ☆																																																																																																																																																																																																																																														
	12" 22" wheel	<input type="checkbox"/> ★	<input type="checkbox"/> ★	<input type="checkbox"/>	<input type="checkbox"/>	<input type="checkbox"/>	<input type="checkbox"/>	<input type="checkbox"/>																																																																																																																																																																																																																																															
	13" 20" wheel	<input type="checkbox"/> ★	<input type="checkbox"/> ★	<input type="checkbox"/> ★	<input type="checkbox"/>	<input type="checkbox"/>	<input type="checkbox"/>	<input type="checkbox"/>	<input type="checkbox"/>	<input type="checkbox"/>	<input type="checkbox"/>	<input type="checkbox"/>																																																																																																																																																																																																																																											
	13" 22" wheel	<input type="checkbox"/> ★	<input type="checkbox"/> ★	<input type="checkbox"/> ★	<input type="checkbox"/>	<input type="checkbox"/>	<input type="checkbox"/>	<input type="checkbox"/>	<input type="checkbox"/>	<input type="checkbox"/>	<input type="checkbox"/>	<input type="checkbox"/>																																																																																																																																																																																																																																											
	14" 20" wheel		<input type="checkbox"/>	<input type="checkbox"/>	<input type="checkbox"/>	<input type="checkbox"/>	<input type="checkbox"/>	<input type="checkbox"/>	<input type="checkbox"/>	<input type="checkbox"/>	<input type="checkbox"/>	<input type="checkbox"/>	<input type="checkbox"/>																																																																																																																																																																																																																																										
	14" 22" wheel		<input type="checkbox"/>	<input type="checkbox"/>	<input type="checkbox"/>	<input type="checkbox"/>	<input type="checkbox"/>	<input type="checkbox"/>	<input type="checkbox"/>	<input type="checkbox"/>	<input type="checkbox"/>	<input type="checkbox"/>	<input type="checkbox"/>																																																																																																																																																																																																																																										
	15" 20" wheel			<input type="checkbox"/>	<input type="checkbox"/>	<input type="checkbox"/>	<input type="checkbox"/>	<input type="checkbox"/>	<input type="checkbox"/>	<input type="checkbox"/>	<input type="checkbox"/>	<input type="checkbox"/>	<input type="checkbox"/>																																																																																																																																																																																																																																										
	15" 22" wheel			<input type="checkbox"/>	<input type="checkbox"/>	<input type="checkbox"/>	<input type="checkbox"/>	<input type="checkbox"/>	<input type="checkbox"/>	<input type="checkbox"/>	<input type="checkbox"/>	<input type="checkbox"/>	<input type="checkbox"/>																																																																																																																																																																																																																																										
	16" 20" wheel			<input type="checkbox"/>	<input type="checkbox"/>	<input type="checkbox"/>	<input type="checkbox"/>	<input type="checkbox"/>	<input type="checkbox"/>	<input type="checkbox"/>	<input type="checkbox"/>	<input type="checkbox"/>	<input type="checkbox"/>																																																																																																																																																																																																																																										
	16" 22" wheel			<input type="checkbox"/>	<input type="checkbox"/>	<input type="checkbox"/>	<input type="checkbox"/>	<input type="checkbox"/>	<input type="checkbox"/>	<input type="checkbox"/>	<input type="checkbox"/>	<input type="checkbox"/>	<input type="checkbox"/>																																																																																																																																																																																																																																										
		☆=Excludes 5" Casters are selected. ★=Excludes STD Frame is are selected.																																																																																																																																																																																																																																																					
10. CAMBER ANGLE <input type="checkbox"/> 0° <input type="checkbox"/> 2° <input type="checkbox"/> 4°			\$ STD																																																																																																																																																																																																																																																				
11. FRONT OF SEATSLING TO FOOTREST <input type="checkbox"/> 12.5" <input type="checkbox"/> 13.0" <input type="checkbox"/> 13.5" <input type="checkbox"/> 14.0" <input type="checkbox"/> 14.5" <input type="checkbox"/> 15.0" <input type="checkbox"/> 15.5" <input type="checkbox"/> 16.0" <input type="checkbox"/> 16.5" <input type="checkbox"/> 17.0"			\$ STD																																																																																																																																																																																																																																																				
*Measurement must be 1.5" shorter than your Front Seat Height																																																																																																																																																																																																																																																							
HIGH MOUNT <input type="checkbox"/> 6.5" <input type="checkbox"/> 7.0" <input type="checkbox"/> 7.5" <input type="checkbox"/> 8.0" <input type="checkbox"/> 8.5" <input type="checkbox"/> 9.0" <input type="checkbox"/> 9.5" <input type="checkbox"/> 10.0" <input type="checkbox"/> 10.5" <input type="checkbox"/> 11.0" <input type="checkbox"/> 11.5" <input type="checkbox"/> 12.0"			\$ 86																																																																																																																																																																																																																																																				
With Risers or Clamps																																																																																																																																																																																																																																																							
12. INSIDE WHEEL CLEARANCE <input type="checkbox"/> 3/4" * <input type="checkbox"/> 1" <input type="checkbox"/> 1 1/4" <input type="checkbox"/> 1 1/2" <input type="checkbox"/> 1 3/4" <input type="checkbox"/> 2"			\$ STD																																																																																																																																																																																																																																																				
*3/4" Inside wheel clearance not available with 2 degree camber. *3/4" Inside wheel clearance not available with armrest.																																																																																																																																																																																																																																																							
NOTE																																																																																																																																																																																																																																																							

1. SEAT WIDTH

Measure from outside of seat tube to the outside of the opposite seat tube.

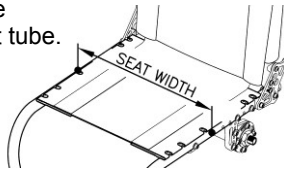

2. SEAT DEPTH

Measure from at the front bottom of backrest tube to the front edge of seat sling.

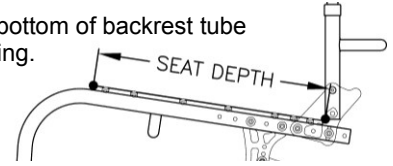

3. FOOTREST WIDTH

Measure from inside of front frame tube to inside of opposite front frame tube.

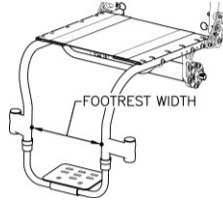

4. FRAME ANGLE

Measure angle frame front to floor.

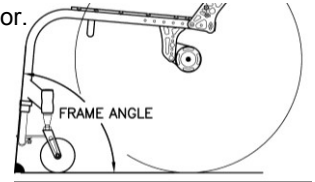

5. BACKREST HEIGHT

Measure from top of back post to seat sling at front bottom of backrest tube.

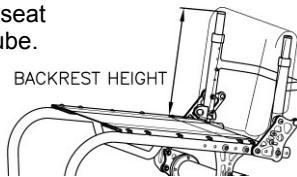

6. BACKREST ANGLE

Measure angle from front of back post to floor.

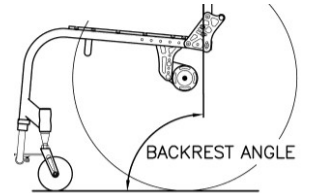

7. FRONT SEAT HEIGHT

Measure from floor to top of seat sling at front edge.

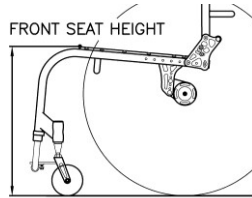

8. REAR SEAT HEIGHT

Measure from floor to top of seat sling at front bottom of backrest tube.

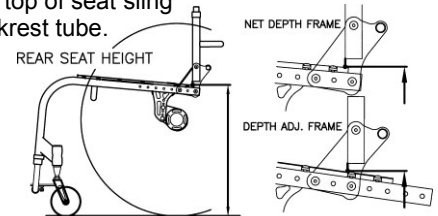

9. CENTER OF GRAVITY

Measure from center of back tube at the folding pivot to the center of the rear axle.

(If welding backrest is selected, Measure from center of back tube at the seat tube to the center of the rear axle.)

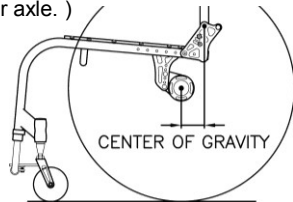

10. CAMBER ANGLE

Measure angle from wheel to vertical at floor.

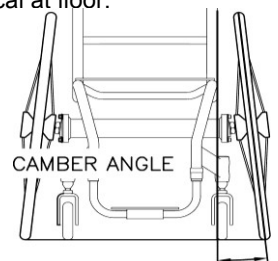

11. FRONT OF SEAT SLING TO FOOTREST

ADULT CHAIR

Measure from top of seat sling at front edge to top of foot plate at front edge.

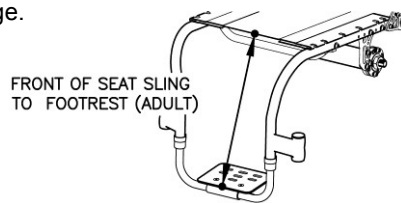

PEDIATRIC CHAIR

Measure vertical from top of seat sling at front edge to top of foot plate.



12. INSIDE WHEEL CLEARANCE

Measure from outside of seat back tube to inside of rear tire.

(If side guards are selected, measure from outside of side guards to inside of rear tire.)

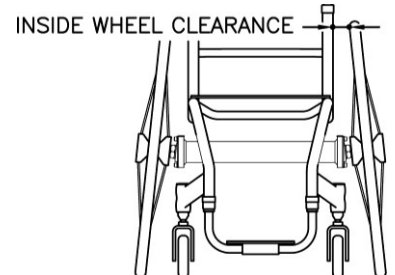

C SPECIAL PARTS COLORS (Please allow an additional 1-2 weeks delivery)

PARTS COLORS						
Powder-Coated	Gloss Black	Twilight Flake	Yellow	Magenta	Fire Engine Red	White
Neon Yellow	Candy Blue	Candy Purple	Candy Green	Candy Red	Candy Raspberry	Cobalt Blue
Brass Metallic	Matte Gray	Matte Purple	Matte Blue	Matte Green	Matte Black	Matte Red
Sparkle Burgundy	Blue Lilac	Neon Green	Orange Sparkle	Mellon Yellow	Gun Smoke Silver	Shocker Yellow
Tiffany Blue		Granny Sparkle Green	Sparkle Sky Blue	Reed Green		
Special Colors	Polished Aluminum					
	24 karat Gold Plated					

Please Choose the Color for each Part

*Parts not selected will be black color. (Suspension Spring: Silver Color)

*Minimum 3 parts selected per order.

*PC=Powder-Coated

Saddle Stops

- PC () \$55
- Polished..... \$132
- Gold Plated..... \$CFP

Backrest

- PC () \$173
- Polished..... \$259
- Gold Plated..... \$CFP

Backrest Brackets

- PC () \$125
- Polished..... \$132
- Gold Plated..... \$CFP

Foot Plate

- PC () \$70
- Polished..... \$104
- Gold Plated..... \$CFP

Footrest Rings

- PC () \$50
- Polished..... \$60
- Gold Plated..... \$CFP

Foot Plate Clamps

- PC () \$70
- Polished..... \$98
- Gold Plated..... \$CFP

Footrest Tubes

- PC..... N/A
- Polished..... \$100
- Gold Plated..... \$CFP

Caps

- PC () \$50
- Polished..... N/A
- Gold Plated..... N/A

Caster Housing

- PC () \$208
- Polished..... \$322
- Gold Plated..... N/A

Front Springs

- PC () \$50
- Polished..... N/A
- Gold Plated..... N/A

Forks & Knurl Nuts

- PC () \$90
- Polished..... \$104
- Gold Plated..... \$CFP

Axle Plates

- PC () \$90
- Polished..... \$110
- Gold Plated..... \$CFP

Camber Plates

- PC () \$90
- Polished..... \$100
- Gold Plated..... \$CFP

Axle Bases

- PC () \$70
- Polished..... \$100
- Gold Plated..... \$CFP

Axle Clamps

- PC () \$100
- Polished..... \$120
- Gold Plated..... \$CFP

Axle Tube

- PC () \$115
- Polished..... \$120
- Gold Plated..... \$CFP

Valid from 2023. Prices & Specifications Are Subject To Change Without Notice.

D COMPONENTS

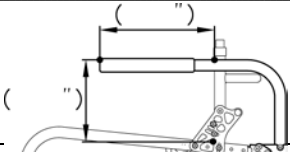
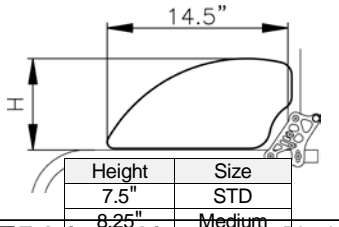
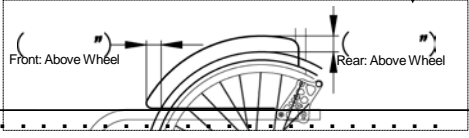
WHEEL LOCKS			
<input type="checkbox"/> New Solutions Push to Lock	<input type="checkbox"/> w/ 2" Extension Handle (\$92up charge)		\$ STD
<input type="checkbox"/> Gallop Push to Lock / Anodized			\$ STD
<input type="checkbox"/> PRIMO Push To Lock			\$ 115
<input type="checkbox"/> Question Mark Style Scissor			\$ 80
<input type="checkbox"/> NEW Compact Scissor Lock / Anodized Black Only			\$ 146
<input type="checkbox"/> Gallop Scissor Lock / Anodized			\$ 146
PUSH HANDLES		*If you are ordering push handles, You must select the backrest locking mechanism.	
<input type="checkbox"/> Integrated w/Fixed Backrest Height / Anodized Black Only			\$ STD
<input type="checkbox"/> Bolt-on / Anodized Black Only	Specify Height from floor -()		\$ 188
<input type="checkbox"/> Bolt-on w/Quick Release / Anodized Black Only	Specify Height from floor -()		\$ 252
<input type="checkbox"/> NEW Height Adj. / Anodized Black Only	Specify Maximum height from floor -()		\$ 390
NEW ARM RESTS		Anodized Black Only	
<input type="checkbox"/> Fixed Tubular Armrest	Adj. Angle and Height	Height from seat sling Set at : <input type="checkbox"/> 8" <input type="checkbox"/> 9" <input type="checkbox"/> 10" <input type="checkbox"/> 11" <input type="checkbox"/> 12" E0973	\$ 330
<input type="checkbox"/> Swing Away Tubular Armrest	Adj. Angle and Height	Height from seat sling Set at : <input type="checkbox"/> 8" <input type="checkbox"/> 9" <input type="checkbox"/> 10" <input type="checkbox"/> 11" <input type="checkbox"/> 12" E0973	\$ 330
<input type="checkbox"/> Flip-Up Armrest	<input type="checkbox"/> w/Fixed Tubular Armrest	Height from seat sling Set at : <input type="checkbox"/> 8" <input type="checkbox"/> 9" <input type="checkbox"/> 10" <input type="checkbox"/> 11" <input type="checkbox"/> 12" E0973	\$ 330
	Adj. Angle <input type="checkbox"/> w/ Swing Away Tubular Armrest	Height from seat sling Set at : <input type="checkbox"/> 8" <input type="checkbox"/> 9" <input type="checkbox"/> 10" <input type="checkbox"/> 11" <input type="checkbox"/> 12" E0973	\$ 330
<input type="checkbox"/> Custom Length & Height (\$173 up charge)		*Specify Height & Length →	
			
ANTI-TIPPERS			
<input type="checkbox"/> Press Release Removable Anti-tipper(pair)		E0971	\$ 330
SIDE GUARDS			
<input type="checkbox"/> Rigid Side Guards - Black ABS	<input type="checkbox"/> Non-Removable <input type="checkbox"/> Removable <input type="checkbox"/> Removable w/Hole (\$14 up charge)		\$ 187
Color: Black Only	Size: <input type="checkbox"/> STD <input type="checkbox"/> Medium <input type="checkbox"/> Cut to Wheel (\$100 up charge) Measurement		
<input type="checkbox"/> Rigid Side Guards - Aluminum	<input type="checkbox"/> Non-Removable <input type="checkbox"/> Removable		\$ 260
	Size: <input type="checkbox"/> Medium Only <input type="checkbox"/> Cut to Wheel (\$100 up charge) Measurement		
	Color <input type="checkbox"/> Black (STD) <input type="checkbox"/> Pol. Aluminum (STD) <input type="checkbox"/> Powder Coated () (\$140 up charge) <input type="checkbox"/> Gold Plate (+CFP)		
			
<input type="checkbox"/> Fabric Clothing Guards	Black Nylon w/Velcro		\$ 108
SEAT CUSHION		-*Please see section for other cushion choices.-	
<input type="checkbox"/> Foam Cushion	w/Nylon Black Cover Thickness <input type="checkbox"/> 1" <input type="checkbox"/> 2" <input type="checkbox"/> 3" <input type="checkbox"/> 4"		\$ CFP
<input type="checkbox"/> Custom Cushion Cover	(Std. Foam Cushion Only) -Select Fabric () (\$104 up charge)		
ACCESSORIES			
<input type="checkbox"/> Frame Protectors	/ Black Leather/Zipper Type		\$ 108
<input type="checkbox"/> Gel Ovation Protector Wraps	Gel Silicone <input type="checkbox"/> Short (1/2") <input type="checkbox"/> Long (3")		\$ 132
<input type="checkbox"/> E0978 Seat Belt	w/Auto Buckle Black Belt Only	E0978	\$ 113
<input type="checkbox"/> Tie Down Brackets	4pcs. <input type="checkbox"/> Bolted <input type="checkbox"/> Welded		\$ 278
<input type="checkbox"/> Calf Strap	<input type="checkbox"/> Black <input type="checkbox"/> Matching Fabric (\$65 up charge) -Select Fabric()		\$ 35
<input type="checkbox"/> Bodypoint Padded Calf Strap	<input type="checkbox"/> (14"-16" footrest width) <input type="checkbox"/> (16"-20" footrest width) <input type="checkbox"/> (20"-24" footrest)		\$ 89 \$95 \$102
<input type="checkbox"/> Hanging Zipper Pouch	<input type="checkbox"/> Black <input type="checkbox"/> Matching Fabric (\$75) or <input type="checkbox"/> Leather (\$80) Custom Size Width: Length:		\$ 86
<input type="checkbox"/> Matching Fabric on Padded Side Guards	-Select Fabric ()		\$ 278
UPHOLSTERY CHOICE & COLOR		*Positioning Back Available. Please see Section E	
<input type="checkbox"/> Standard Adjustable Height Backrest	(Black)		\$ STD
<input type="checkbox"/> Adjustable Tension Backrest	Black Only (*Not available with 8" Backrest Height)		\$ 173
Options	<input type="checkbox"/> Fun Fabric: For Std. or Adj. Style (Choose From Choices on Page 7 and write below) (\$ 92 up charge)		
	<input type="checkbox"/> Backrest Leather Trim (outside panels) (\$ up charge)		\$ CFP

FABRIC CHOICE SHEET
 OR
 (PROVIDE 3 YARDS OF CHOICE OF FABRIC)

1. SNOOPY



2. TINKER BELL



3. Bouncy Sports



4. POKEMON



5. CARS



6. BATMAN



7. PATTERN AIRPLANES



8. Plaid- Clifford



9. Princess



10. BALLARINA



11. SPORTY



12. Winnie The Pooh



13. Work Trucks Fabric



14. HELLO KITTY



15. Scooby Doo



16. Strawberry Shortcake



17. Traffic Cars





18. SuperBikes



E TIRES, CASTERS, & FORKS

TIRES					
<input type="checkbox"/> Low Pressure Tire		<input type="checkbox"/> 20"x1-3/8" or <input type="checkbox"/> 22"x1-3/8" Gray		E2211/E2212	\$ STD
<input type="checkbox"/> Schwalbe Right Run High Pressure Tire		<input type="checkbox"/> 20 x 1(451)		E2211/E2212	\$ NCO
<input type="checkbox"/> 22"x1"(501)		Gray Tire with black wall Only			
<input type="checkbox"/> Solid Tire		<input type="checkbox"/> 20"x1" (451) <input type="checkbox"/> Dark Gray <input type="checkbox"/> 22 x 1 <input type="checkbox"/> Black Only(\$30)		E2218	\$ 178
<input type="checkbox"/> E2213 Flat-Free Inserts		For 20"x1-3/8" or 22"x1-3/8" Tires Only		E2211/E2213	\$ 155
<input type="checkbox"/> Schwalbe Marathon Plus High Pressure Tire		<input type="checkbox"/> 22 x 1 Only			\$ 170
CASTERS					
SIZE	TIRE WIDTH	HUB COLOR	TIRE COLOR	DESCRIPTION	
<input type="checkbox"/> 3"	1"	Black Hub	Black Tire Only	Polyurethane	\$ STD
<input type="checkbox"/> 3"	1"	Plastic Black Hub	Clear Tire Only	Lighted, Polyurethane	\$ 86
<input type="checkbox"/> 3"	1"	Red Hub	Red Tire Only	Polyurethane	\$ STD
<input type="checkbox"/> 3"	1"	Black Hub	Clear Tire Only	Polyurethane	\$ STD
<input type="checkbox"/> 3"	1"	Aluminum Silver Hub	Black Tire Only	Made By Frog Legs	\$ 209
<input type="checkbox"/> 3"	1"	Aluminum Black Hub	Black Tire Only	Made By Frog Legs	\$ 209
<input type="checkbox"/> 3"	1.5"	Aluminum Silver Hub	Black Tire Only	Soft Roll Made By Frog Legs	\$ 209
<input type="checkbox"/> 3"	1.5"	Aluminum Black Hub	Black Tire Only	Soft Roll Made By Frog Legs	\$ 209
<input type="checkbox"/> 4"	1 1/8"	Plastic Black Hub	Black Tire Only	Polyurethane E2222	\$ STD
<input type="checkbox"/> 4"	1"	Plastic Black Hub	Clear Only	Lighted, Polyurethane	\$ 86
<input type="checkbox"/> 4"	1"	Aluminum Silver Hub	Black Tire Only	Made By Frog Legs	\$ 209
<input type="checkbox"/> 4"	1"	Aluminum Black Hub	Black Tire Only	Made By Frog Legs	\$ 209
<input type="checkbox"/> 4"	1.5"	Aluminum Silver Hub	Tire <input type="checkbox"/> Black <input type="checkbox"/> Blue <input type="checkbox"/> Red	Soft Roll Made By Frog Legs	\$ 209
<input type="checkbox"/> 4"	1.5"	Aluminum Black Hub	Black Tire Only	Soft Roll Made By Frog Legs	\$ 209
<input type="checkbox"/> 5"	1"	Composite Black Hub	Black Tire Only		\$ STD
<input type="checkbox"/> 5"	1"	Plastic Black Hub	Clear Tire Only	Lighted, Polyurethane	\$ 86
<input type="checkbox"/> 5"	1"	Aluminum Silver Hub	Black Tire Only	Made By Frog Legs	\$ 209
<input type="checkbox"/> 5"	1"	Aluminum Black Hub	Black Tire Only	Made By Frog Legs	\$ 209
<input type="checkbox"/> 5"	1.5"	Aluminum Silver Hub	Tire <input type="checkbox"/> Black <input type="checkbox"/> Blue <input type="checkbox"/> Red	Soft Roll Made By Frog Legs	\$ 209
<input type="checkbox"/> 5"	1.5"	Aluminum Black Hub	Black Tire Only	Soft Roll Made By Frog Legs	\$ 209
<input type="checkbox"/> "	<input type="checkbox"/> 1"OR <input type="checkbox"/> 1.5"	Hub Color:	Tread Color:	Soft Roll Made By Frog Legs	\$ CFP
FORKS					
<input type="checkbox"/> Frog Leg Shields(4 pcs) Only for FrogLeg Forks					\$ 30
<input type="checkbox"/> STD Aluminum Forks		Black Only			\$ STD
Extra Options for Aluminum Forks		<input type="checkbox"/> With Suspension		E1015	\$ 72
		<input type="checkbox"/> With Quick Release Axles		K0073	\$ 141
<input type="checkbox"/> Frog Leg Suspension Forks Std 1" Wide		(For 3", 4" x 1" width Caster and 5" lighted)		(Not available with Quick Release Axles)	
User's	Color	<input type="checkbox"/> Anodized Black	<input type="checkbox"/> Anodized Silver	Or STD 4" x 1 1/8" Casters)	E1015 \$ 607
<input type="checkbox"/> Frog Leg Suspension Forks 1.5" Wide		(For 3", 4" x 1.5" width Caster and 5" Caster)		(Not available with Quick Release Axles)	
User's	Color	<input type="checkbox"/> Anodized Black	<input type="checkbox"/> Anodized Silver		E1015 \$ 607

F WHEELS

WHEELS														
Wire Wheels	<input type="checkbox"/> 20" (451) <input type="checkbox"/> 22" (501)		\$ NCO											
Spinergy Spox 18 Spokes 	<input type="checkbox"/> 20" (451) <input type="checkbox"/> 22" (501) Spoke Color <input type="checkbox"/> Black <input type="checkbox"/> Red <input type="checkbox"/> Yellow <input type="checkbox"/> Blue <input type="checkbox"/> White <small>With Silver Hub With Black Hub With Black Hub With Black Hub With Black Hub</small>		\$ 998											
	<input type="checkbox"/> Custom Color Spoke Pattern <table border="1" style="display: inline-table; margin-left: 10px;"> <tr> <td></td> <td>Left Wheel</td> <td>Right Wheel</td> </tr> <tr> <td>Spokes</td> <td></td> <td></td> </tr> <tr> <td>Color</td> <td></td> <td></td> </tr> <tr> <td>Hub Color</td> <td><input type="checkbox"/> Black/<input type="checkbox"/> Silver</td> <td><input type="checkbox"/> Black/<input type="checkbox"/> Silver</td> </tr> </table>		Left Wheel	Right Wheel	Spokes			Color			Hub Color	<input type="checkbox"/> Black/ <input type="checkbox"/> Silver	<input type="checkbox"/> Black/ <input type="checkbox"/> Silver	\$ 1,108
		Left Wheel	Right Wheel											
Spokes														
Color														
Hub Color	<input type="checkbox"/> Black/ <input type="checkbox"/> Silver	<input type="checkbox"/> Black/ <input type="checkbox"/> Silver												
Spinergy LX 12 Spokes 	<input type="checkbox"/> 22" (501) Spoke Color <input type="checkbox"/> Black <input type="checkbox"/> Red <input type="checkbox"/> Yellow <input type="checkbox"/> Blue <small>With Silver Hub With Black Hub With Black Hub With Black Hub</small> <input type="checkbox"/> White <input type="checkbox"/> Neon Green <input type="checkbox"/> Pink <input type="checkbox"/> Orange <small>With Black Hub With Black Hub With Black Hub With Black Hub</small> <input type="checkbox"/> Purple With Black Hub		\$ 1,252											
	<input type="checkbox"/> Custom Color Spoke Pattern <table border="1" style="display: inline-table; margin-left: 10px;"> <tr> <td></td> <td>Left Wheel</td> <td>Right Wheel</td> </tr> <tr> <td>Spokes</td> <td></td> <td></td> </tr> <tr> <td>Color</td> <td></td> <td></td> </tr> <tr> <td>Hub Color</td> <td><input type="checkbox"/> Black/<input type="checkbox"/> Silver</td> <td><input type="checkbox"/> Black/<input type="checkbox"/> Silver</td> </tr> </table>		Left Wheel	Right Wheel	Spokes			Color			Hub Color	<input type="checkbox"/> Black/ <input type="checkbox"/> Silver	<input type="checkbox"/> Black/ <input type="checkbox"/> Silver	\$ 1,362
		Left Wheel	Right Wheel											
Spokes														
Color														
Hub Color	<input type="checkbox"/> Black/ <input type="checkbox"/> Silver	<input type="checkbox"/> Black/ <input type="checkbox"/> Silver												
HANDRIMS														
Type	<input type="checkbox"/> Standard For 20"& 22" Wheel Anodized Silver		\$ STD											
	<input type="checkbox"/> Vinyl Coated For 20"& 22" Wheel		\$ 200											
	<input type="checkbox"/> Natural Fit For 22" Wheel Only													
	<input type="checkbox"/> Standard Grip (Not available with short tabs.)		\$ 570											
	<input type="checkbox"/> Super Grip (Not available with short tabs.)		\$ 645											
	<input type="checkbox"/> Without Thumb Grip		\$ 338											
	<input type="checkbox"/> Natural Fit (LT) For 22" Wheel Only													
	<input type="checkbox"/> Standard Grip (Not available with short tabs.)		\$ 629											
	<input type="checkbox"/> Super Grip (Not available with short tabs.)		\$ 706											
	<input type="checkbox"/> Without Thumb Grip		\$ 400											
<input type="checkbox"/> The Surge Handrims		\$ 553												
<input type="checkbox"/> The Surge Handrims (LT)		\$ 603												
<input type="checkbox"/> The Q-Grip Handrims : anti-slip, latex-free, neoprene coating. 22" Only		\$ 543												
<input type="checkbox"/> OMIT HANDRIMS		\$ NCO												
TAB LENGTH	<input type="checkbox"/> Long Tabs(STD inside clearance 3/4") *		\$ STD											
	<input type="checkbox"/> Short Tabs(Inside clearance 1/2")* Not available with Natural Fit Handrim with thumb grip		\$ STD											
	<input type="checkbox"/> Short Tab (Set closest to wheel cut off excess)		\$ 35											

G CHAIR OPTIONS 1/3

SEAT CUSHION			
SUPRACOR® WHEELCHAIR CUSHIONS			
Stimulite® Contoured Cushion	<input type="checkbox"/> W14"xD16" (CD1416)	E2603	\$ 707
*Black Upholstery only	<input type="checkbox"/> W16"xD16" (CD1616)	E2603	\$ 707
*Comes with Zipper Pouch	<input type="checkbox"/> Extra Sensitive (\$35 up charge)		
<input type="checkbox"/> Extra Cover (\$120 up charge)	<input type="checkbox"/> Sling Style Bottom (\$52up)		
	<input type="checkbox"/> Custom Size (\$ CFP)		
	W(") x D(")		
Stimulite® Slimline Cushion	<input type="checkbox"/> W14"xD16" (SM1416)	E2603	\$ 446
*Black Upholstery only	<input type="checkbox"/> W16"xD16" (SM1616)	E2603	\$ 446
<input type="checkbox"/> Extra Cover (\$86 up charge)	<input type="checkbox"/> Extra Sensitive (\$35 up charge)		
<input type="checkbox"/> Custom Size (\$- CFP)	<input type="checkbox"/> Sling Style Bottom (\$52 up charge)		
Stimulite® Corbee Pediatric Cushion	<input type="checkbox"/> W10"xD10" (PD1010)	E2603	\$ 342
*Black Upholstery only	<input type="checkbox"/> W12"xD12" (PD1212)	E2603	\$ 342
<input type="checkbox"/> Extra Cover (\$86 up charge)	<input type="checkbox"/> W14"xD14" (PD1414)	E2603	\$ 342
	<input type="checkbox"/> Extra Sensitive (\$35 up charge)		
	<input type="checkbox"/> Sling Style Bottom (\$52 up charge)		
	<input type="checkbox"/> Custom Size W(") x D(") (\$CFP)		
ROHO WHEELCHAIR CUSHIONS			
<input type="checkbox"/> 4" HIGH PROFILE® QUADTRO SELECT® CUSHION	*Black Upholstery	<input type="checkbox"/> Extra Cover (+\$100)	E2622-2623 \$ 669
Choose Size	<input type="checkbox"/> W12"xD12" <input type="checkbox"/> W12"xD13" <input type="checkbox"/> W13"xD13" <input type="checkbox"/> W13"xD15" <input type="checkbox"/> W13"xD16" <input type="checkbox"/> W15"xD13" <input type="checkbox"/> W15"xD15"		
	<input type="checkbox"/> W15"xD16" <input type="checkbox"/> W15"xD18" <input type="checkbox"/> W16"xD15"		
	<input type="checkbox"/> Custom Size W(") x D(") (\$CFP)		
<input type="checkbox"/> 3" MID PROFILE® QUADTRO SELECT® CUSHION	*Black Upholstery only	<input type="checkbox"/> Extra Cover (+\$100)	E2622-2623 \$ 669
Choose Size	<input type="checkbox"/> W12"xD12" <input type="checkbox"/> W12"xD13" <input type="checkbox"/> W13"xD13" <input type="checkbox"/> W13"xD15" <input type="checkbox"/> W13"xD16" <input type="checkbox"/> W15"xD13"		
	<input type="checkbox"/> W15"xD15" <input type="checkbox"/> W15"xD16" <input type="checkbox"/> W15"xD18" <input type="checkbox"/> W16"xD15" <input type="checkbox"/> W16"xD16"		
	<input type="checkbox"/> Custom Size W(") x D(") (\$CFP)		
<input type="checkbox"/> 2" LOW PROFILE® QUADTRO SELECT® CUSHION	*Black Upholstery only	<input type="checkbox"/> Extra Cover (+\$100)	E2622-2623 \$ 669
Choose Size	<input type="checkbox"/> W12"xD12" <input type="checkbox"/> W12"xD13" <input type="checkbox"/> W13"xD13" <input type="checkbox"/> W13"xD15" <input type="checkbox"/> W13"xD16" <input type="checkbox"/> W15"xD13" <input type="checkbox"/> W15"xD15"		
	<input type="checkbox"/> W15"xD16" <input type="checkbox"/> W15"xD18" <input type="checkbox"/> W16"xD15" <input type="checkbox"/> W16"xD16"		
	<input type="checkbox"/> Custom Size W(") x D(") (\$CFP)		
THE CURVE CUSHION	<input type="checkbox"/> W10"xD10" <input type="checkbox"/> W10"xD11" <input type="checkbox"/> W10"xD11" <input type="checkbox"/> W10"xD12" <input type="checkbox"/> W11"xD12" <input type="checkbox"/> W12"xD12"		\$ 146
*Black Upholstery only	<input type="checkbox"/> W12"xD13" <input type="checkbox"/> W12"xD14" <input type="checkbox"/> W13"xD11" <input type="checkbox"/> W13"xD12" <input type="checkbox"/> W13"xD13" <input type="checkbox"/> W13"xD14"		
<input type="checkbox"/> Extra Cover (+\$46)	<input type="checkbox"/> W14"xD14" <input type="checkbox"/> W14"xD15" <input type="checkbox"/> W14"xD16" <input type="checkbox"/> W15"xD14" <input type="checkbox"/> W15"xD15" <input type="checkbox"/> W15"xD16"		
	<input type="checkbox"/> W16"xD14" <input type="checkbox"/> W16"xD15" <input type="checkbox"/> W16"xD16"		

G CHAIR OPTIONS 2/3

SEAT CUSHION			
Exgel Kaji Cushion			
For Comfortable Sitting To Prevent Pressure Sores			
<input type="checkbox"/> Owl Regular(1.6" Thick) Incontinence Cover Only	<input type="checkbox"/> W14"xD16" <input type="checkbox"/> W15"xD16" <input type="checkbox"/> W16"xD16" <input type="checkbox"/> W18"xD16" * No Custom Sizes	E2603 \$ 362 E2603 \$ 362 E2603 \$ 362 E2603 \$ 408	
<input type="checkbox"/> Owl High(3.1" Thick) Incontinence Cover Only	<input type="checkbox"/> W14"xD16" <input type="checkbox"/> W15"xD16" <input type="checkbox"/> W16"xD16" <input type="checkbox"/> W18"xD16" <input type="checkbox"/> W18"xD18" * No Custom Sizes	E2603 \$ 437 E2603 \$ 437 E2603 \$ 437 E2603 \$ 495 E2603 \$ 495	
<input type="checkbox"/> Owl Contour(3.0" Thick) Incontinence Cover Only	<input type="checkbox"/> W14"xD16" <input type="checkbox"/> W15"xD16" <input type="checkbox"/> W16"xD16" <input type="checkbox"/> W18"xD16"	E2603 \$ 454 E2603 \$ 454 E2603 \$ 454 E2603 \$ 495	
<input type="checkbox"/> Owl Deep Contour(4.3" Thick) <input type="checkbox"/> W14"xD16" \$ 458 * No Custom Sizes- Incontinence Cover Only <input type="checkbox"/> W14"xD16" \$518 <input type="checkbox"/> W15"xD16" \$518 <input type="checkbox"/> W16"xD16" \$518 <input type="checkbox"/> W18"xD16" \$558			
<input type="checkbox"/> Standard Regular(1.4" Thick) Easy to Use Flat Style (superior pressure redistribution) .. For Pressure Relief E2622-2623 <input type="checkbox"/> W12" x D12" \$368 <input type="checkbox"/> W13" x D13" \$368 <input type="checkbox"/> W14" x D14" \$368 <input type="checkbox"/> W14" x D16" \$368 <input type="checkbox"/> W16" x D16" \$368 <input type="checkbox"/> W16" x D17" \$368 <input type="checkbox"/> W17" x D16" \$368 <input type="checkbox"/> W17" x D17" \$368 <input type="checkbox"/> W18" x D16" \$391 <input type="checkbox"/> W18" x D18" \$391 <input type="checkbox"/> W18" x D19" \$440 <input type="checkbox"/> W18" x D20" \$440 <input type="checkbox"/> W19" x D19" \$440			
<input type="checkbox"/> Standard High(2.6" Thick) Incontinence Cover Only E2622 *Black Upholsterv only <input type="checkbox"/> W12" x D12" \$383 <input type="checkbox"/> W13" x D13" \$ 383 <input type="checkbox"/> W14" x D14" \$383 <input type="checkbox"/> W14" x D16" \$ 383 <input type="checkbox"/> W16" x D16" \$383 <input type="checkbox"/> W16" x D17" \$383 <input type="checkbox"/> W17" x D16" \$383 <input type="checkbox"/> W17" x D17" \$383 <input type="checkbox"/> W18" x D16" \$460 <input type="checkbox"/> W18" x D18" \$460 <input type="checkbox"/> W18" x D19" \$512 <input type="checkbox"/> W18" x D20" \$512 <input type="checkbox"/> W19" x D19" \$512 <input type="checkbox"/> W18" x D19" \$512			
<input type="checkbox"/> Standard Anti-Thrust(2.6" Thick) * No Custom Sizes Incontinence Cover Only	<input type="checkbox"/> W16 x D16 \$460 <input type="checkbox"/> W18 x D16 \$500 <input type="checkbox"/> W18 x D18 \$500	Prevents Unwanted Forward Movement of lower back and hip bone	
<input type="checkbox"/> Lite Regular(2.2" Thick)	<input type="checkbox"/> W16" x D16" \$374 <input type="checkbox"/> W18" x D16" \$397 <input type="checkbox"/> W18" x D18" \$397 * No Custom Sizes- Incontinence Cover Only		
<input type="checkbox"/> Lite High(3.0" Thick)	<input type="checkbox"/> W16" x D16" \$408 <input type="checkbox"/> W18" x D16" \$431 <input type="checkbox"/> W18" x D18" \$431 * No Custom Sizes- Incontinence Cover Only		

H CHAIR OPTIONS 3/3

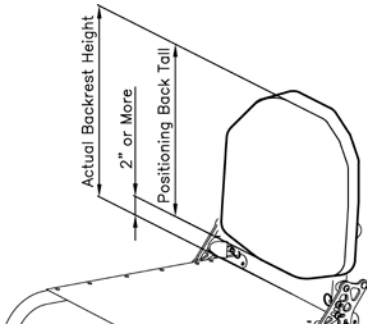
POSITIONING BACK			
<p>*Note : Actual height of the backrest will increase 2" or more.</p> 			
ADI CARBON BACKREST (Support Contour-ACTIVE 2.5")			
Mounting Hardware: <input type="checkbox"/> 2 Point Pro <input type="checkbox"/> Quick Release			
Height	<input type="checkbox"/> LOW (10" Tall) *Backrest Height requires 12" or more	*Available 13"-19" width	Width (") E2613 \$ 986
	<input type="checkbox"/> Medium (13" Tall) *Backrest Height requires 15" or more	*Available 13"-19" width	Width (") E2613 \$ 1,078
<input type="checkbox"/> Add Privacy Flap (\$80 up charge)	<input type="checkbox"/> Standard (16" Tall) *Backrest Height requires 18" or more	*Available 13"-19" width	Width (") E2613 \$ 1,164
	<input type="checkbox"/> Custom Size (" Tall) x (" width)	E2613 \$ CFP
ADI ALUMINUM BACKREST (Support Contour-ACTIVE 2.5")			
Mounting Hardware: <input type="checkbox"/> 2 Point Pro <input type="checkbox"/> Quick Release			
Height	<input type="checkbox"/> LOW (10" Tall) *Backrest Height requires 12" or more	*Available 10"-20" width	Width (") E2613 \$ 807
	<input type="checkbox"/> Medium (13" Tall) *Backrest Height requires 15" or more	*Available 12"-20" width	Width (") E2613 \$ 827
	<input type="checkbox"/> Standard (16" Tall) *Backrest Height requires 18" or more	*Available 14"-20" width	Width (") E2613 \$ 846
	<input type="checkbox"/> Tall (18" Tall) *Backrest Height requires 20" or more	*Available 16"-20" width	Width (") E2613 \$ 866
<input type="checkbox"/> Add Privacy Flap (\$80 up charge)	<input type="checkbox"/> X-Tall (20" Tall) *Backrest Height requires 22" or more	*Available 16"-20" width	Width (") E2613 \$ 886
	<input type="checkbox"/> Custom Size (" Tall) x (" width)	E2613 \$ CFP
ADI ALUMINUM BACKREST (Support Contour-DEEP 4") *Not Available with Lateral Supports			
Mounting Hardware: <input type="checkbox"/> 2 Point Pro <input type="checkbox"/> Quick Release			
Height	<input type="checkbox"/> LOW (10" Tall) *Backrest Height requires 12" or more	*Available 10"-20" width	Width (") E2615 \$ 940
	<input type="checkbox"/> Medium (13" Tall) *Backrest Height requires 15" or more	*Available 12"-20" width	Width (") E2615 \$ 959
	<input type="checkbox"/> Standard (16" Tall) *Backrest Height requires 18" or more	*Available 14"-20" width	Width (") E2615 \$ 979
	<input type="checkbox"/> Tall (18" Tall) *Backrest Height requires 20" or more	*Available 16"-20" width	Width (") E2615 \$ 998
<input type="checkbox"/> Add Privacy Flap (\$80 up charge)	<input type="checkbox"/> X-Tall (20" Tall) *Backrest Height requires 22" or more	*Available 16"-20" width	Width (") E2615 \$ 1,019
	<input type="checkbox"/> Custom Size (" Tall) x (" width)	E2615 \$ CFP
ADI LATERAL SUPPORTS (Lateral Supports are compatible with only active 2.5" ADI positioning back.)			
<input type="checkbox"/> Stationary Pad	Pad Size <input type="checkbox"/> Small (3" H x 3" D) <input type="checkbox"/> Medium(3" H x 4" D) <input type="checkbox"/> Large(4.5" H x 4.5" D) <input type="checkbox"/> Large(4" H x 6" D)		
	<input type="checkbox"/> Pair	\$ 422	
	<input type="checkbox"/> Left side only or <input type="checkbox"/> Right side only	\$ 211	
<input type="checkbox"/> Swing-Out	Pad Size <input type="checkbox"/> Small (3" H x 3" D) <input type="checkbox"/> Medium(3" H x 4" D) <input type="checkbox"/> Large(4.5" H x 4.5" D) <input type="checkbox"/> Large(4" H x 6" D)		
	<input type="checkbox"/> Pair	\$ 688	
	<input type="checkbox"/> Left side only or <input type="checkbox"/> Right side only	\$ 344	
OTHER			
<input type="checkbox"/> ADI Transfer Board	<input type="checkbox"/> 21" (ADV21) <input type="checkbox"/> 24" (ADV24) <input type="checkbox"/> 29"(ADV29)	\$ 82	
<input type="checkbox"/> ADI Push and Transfer Gloves with Leather (one size) (ADGL)	\$ 110		
<input type="checkbox"/> ADI Push and Transfer Gloves with Rubber Grip (one size) (ADG)	\$ 110		
<input type="checkbox"/> ADI Carbon Solid Seat (Wide: 18" Max, Depth: 20") ※ ONLY AVAILABLE WITH COLOURS NON-REMOVABLE SIDE GUARDS	\$ 827		
VARILITE® Seating Systems Available			CFP
Please visit for all options. www.varilite.com			
NOTE			