

ECLIPSE

DEALER		COLOURS INFORMATION For Office Use Only	
Dealer:		Order Date:	S/N:
Account:	P.O.#:		
Ordered By:			
Customer Name:			
Customer Weight:			

CHAIR INFORMATION	PRICE
ECLIPSE HCPC K0005	Base Wheel Chair Price K0005 \$ 4,800
Adjustable FSH-RSH	Total Section A \$
Max. Capacity 250Lbs	Total Section B \$
<input type="checkbox"/> Heavy Duty Frame(250-300lbs) \$750	Total Section C \$
<input type="checkbox"/> Super Heavy Duty Frame(300-350lbs) \$1,500	Total Section D \$
NOTE	Total Section E \$
Main Frame : ZK55 & ZK60 High Grade A7000 Series Aluminum	Total Section F \$
Main Frame : Lifetime Warranty(5 YEARS)	Total Section G \$
	ORDER GRAND TOTAL \$

A FRAME COLORS & PARTS COLORS

FRAME COLORS		
<input type="checkbox"/> Powder-Coated <input type="checkbox"/> Reed Green <input type="checkbox"/> Brass Metallic <input type="checkbox"/> Tiffany Blue <input type="checkbox"/> Blue Lilac <input type="checkbox"/> Sparkle Burgundy <input type="checkbox"/> Gloss Black <input type="checkbox"/> Candy Blue <input type="checkbox"/> Matte Gray <input type="checkbox"/> Neon Yellow <input type="checkbox"/> Twilight Flake <input type="checkbox"/> Candy Purple <input type="checkbox"/> Matte Purple <input type="checkbox"/> Neon Green <input type="checkbox"/> Granny Sparkle Green <input type="checkbox"/> Yellow <input type="checkbox"/> Candy Green <input type="checkbox"/> Matte Blue <input type="checkbox"/> Orange Sparkle <input type="checkbox"/> Sparkle Sky Blue <input type="checkbox"/> Shocker Yellow <input type="checkbox"/> Magenta <input type="checkbox"/> Candy Red <input type="checkbox"/> Matte Green <input type="checkbox"/> Mellon Yellow <input type="checkbox"/> Fire Engine Red <input type="checkbox"/> Candy Raspberry <input type="checkbox"/> Matte Black <input type="checkbox"/> Gun Smoke <input type="checkbox"/> White <input type="checkbox"/> Cobalt Blue <input type="checkbox"/> Matte Red		\$ STD
Special Colors <input type="checkbox"/> Polished <input type="checkbox"/> 24 karat Gold		\$ 920 \$ CFP
<input type="checkbox"/> NO LOGOS ON ENTIRE		
PARTS COLORS		
STD Color Black Color (*Suspension Springs-Silver Color Only)-		\$ STD
Custom Color Main Bolt on Parts One Color Package Including: Backrest, Foot Plate, Footrest Rings, Backrest Brackets, Saddle Stops, Forks & Knurl Nuts, Caps, Front Suspension Springs, Caster Housings Axle Plate & Axle Base ☆marked parts	<input type="checkbox"/> Powder-Coated ():- <input type="checkbox"/> Polished <input type="checkbox"/> 24 karat Gold	\$ 690 \$ 863 \$ CFP

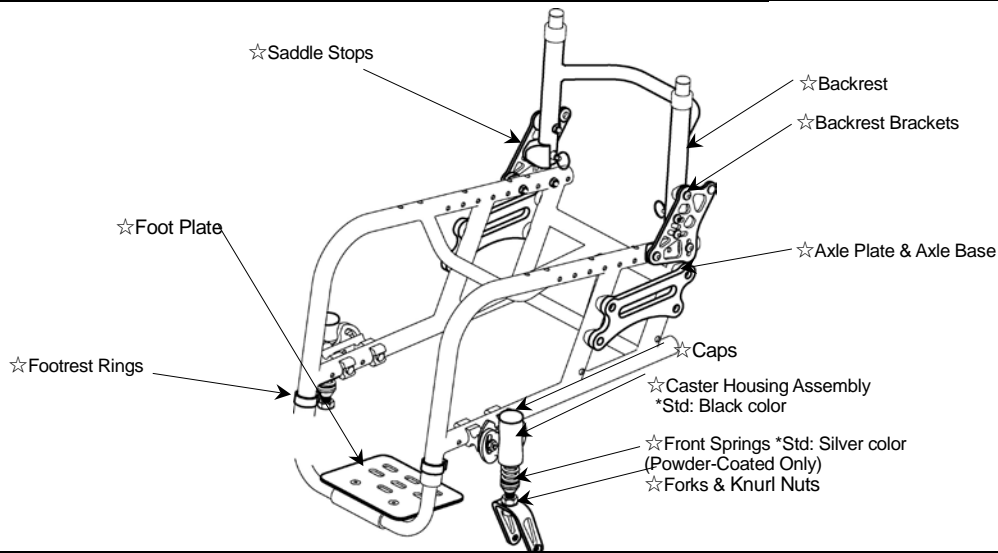

B FRAME MEASUREMENTS 1/2

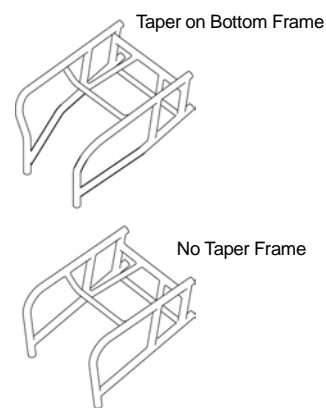
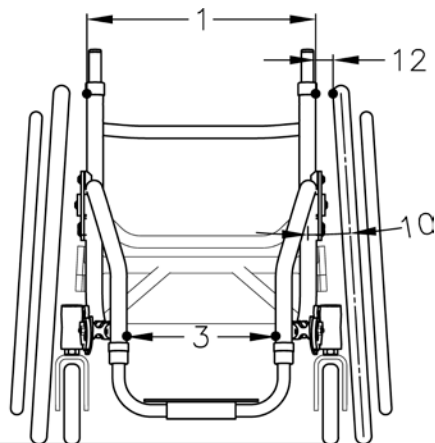
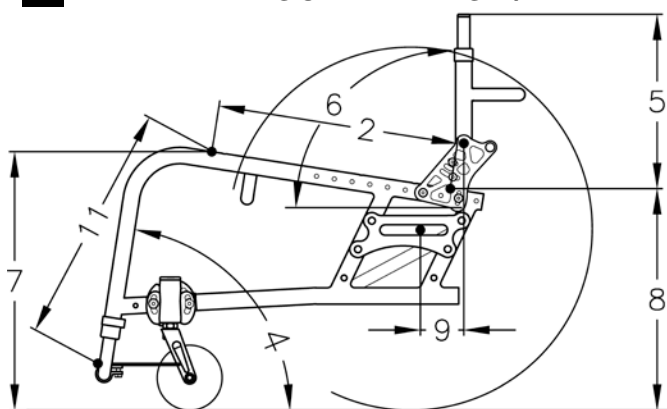

1. SEAT WIDTH	<input type="checkbox"/> 13" <input type="checkbox"/> 14" <input type="checkbox"/> 15" <input type="checkbox"/> 16" <input type="checkbox"/> 17" <input type="checkbox"/> 18" <input type="checkbox"/> 19".....	\$ STD								
	<input type="checkbox"/> 20" E2201	\$ 345								
2. SEAT DEPTH * Only Choose One Option	<input type="checkbox"/> 14" <input type="checkbox"/> 15" <input type="checkbox"/> 16" <input type="checkbox"/> 17" <input type="checkbox"/> 18" <input type="checkbox"/> 19".....	\$ STD								
	<input type="checkbox"/> 20" E2203	\$ 285								
<input type="checkbox"/> Aluminum Seat Pan(250-300lbs) Recommend \$ 324 <input type="checkbox"/> Welded Aluminum Seat Pan(300-350lbs) Recommend \$ 250 <input type="checkbox"/> Positioning Frame Add (") \$ 200										
3. FOOTREST WIDTH	<input type="checkbox"/> STD (Seat Width Minus 5", Taper on Bottom Frame)	\$ STD								
	<input type="checkbox"/> Custom (") * Taper on Bottom Frame Only	\$ 173								
	<input type="checkbox"/> No Taper (Seat Width Minus 2").....	\$ NCO								
FOOT PLATE STYLE	<input type="checkbox"/> Standard single loop with adjust. height & angle. STD Foot Plate	K0040 \$ STD								
	<input type="checkbox"/> Single Flip-Back-single loop (no riser avail) with adjust. height & angle. STD Foot Plate	K0040 \$ 173								
	<input type="checkbox"/> Dual Flip Up w/ Welded Stabilizer Bar (\$250 up charge)									
	<input type="checkbox"/> Custom Foot Plate with adjust. height & angle	K0040 \$ 115								
<p>STD Foot Plate Size Chart</p> <table border="1"> <thead> <tr> <th>Your Footrest Width</th> <th>Foot Plate Size</th> </tr> </thead> <tbody> <tr> <td>8.0" - 10.5"</td> <td>W6.5"xD5"</td> </tr> <tr> <td>11.0" - 12.5"</td> <td>W8.5"xD6.5"</td> </tr> <tr> <td>13.0" - 17.0"</td> <td>W11"xD6.5"</td> </tr> </tbody> </table>			Your Footrest Width	Foot Plate Size	8.0" - 10.5"	W6.5"xD5"	11.0" - 12.5"	W8.5"xD6.5"	13.0" - 17.0"	W11"xD6.5"
Your Footrest Width	Foot Plate Size									
8.0" - 10.5"	W6.5"xD5"									
11.0" - 12.5"	W8.5"xD6.5"									
13.0" - 17.0"	W11"xD6.5"									
<p><input type="checkbox"/> Custom Tubular Footrest</p>										
<p>*Not Available High Mount Footrest.</p> <p>*Measurement must be 2.5" shorter than your Footrest Width</p> <p><input type="checkbox"/> With ABS Foot Plate (\$86 up charge)</p>										
4. FRAME ANGLE	<input type="checkbox"/> 75° <input type="checkbox"/> 80° <input type="checkbox"/> 85° <input type="checkbox"/> 90° to the ground	\$ STD								
	<input type="checkbox"/> Custom (°) to the ground	\$ NCO								

B FRAME MEASUREMENTS 2/2

5. BACKREST HEIGHT <small>* Rigidizer bar 3.25" deep std.</small>	<input type="checkbox"/> 8" <input type="checkbox"/> 9" <input type="checkbox"/> 10" <input type="checkbox"/> 11" <input type="checkbox"/> 12" <input type="checkbox"/> 13" <input type="checkbox"/> 14" <input type="checkbox"/> 15" <input type="checkbox"/> 16" <input type="checkbox"/> 17" <input type="checkbox"/> 18"	\$ STD																																																																																																				
Type	<input type="checkbox"/> Locking mechanism with adjust. height & angle	\$ STD																																																																																																				
	<input type="checkbox"/> Double Locking mechanism with adjust. height & angle	\$ 40																																																																																																				
	<input type="checkbox"/> Folding with adjust. height & angle	\$ NCO																																																																																																				
<input type="checkbox"/> Custom Backrest - (ie: double rigidizer bars, custom depth, custom height, etc)		\$ 200																																																																																																				
6. BACKREST ANGLE	Set at (°) to the ground *STD 90°	\$ STD																																																																																																				
7. FRONT SEAT HEIGHT	<input type="checkbox"/> 17.5" <input type="checkbox"/> 18.0" <input type="checkbox"/> 18.5" <input type="checkbox"/> 19.0" <input type="checkbox"/> 19.5" <input type="checkbox"/> 20.0" <input type="checkbox"/> 20.5" <input type="checkbox"/> 21.0"	\$ STD																																																																																																				
Front Seat Height Ranges <small>*=Not Available with Quick Release Caster Axle.</small> The front seat heights are impacted by the size of your front caster.	<table border="1" style="width:100%; border-collapse: collapse;"> <thead> <tr> <th colspan="2" rowspan="2"></th> <th colspan="8">Front Seat Height</th> </tr> <tr> <th>17.5"</th> <th>18.0"</th> <th>18.5"</th> <th>19.0"</th> <th>19.5"</th> <th>20.0"</th> <th>20.5"</th> <th>21.0"</th> </tr> </thead> <tbody> <tr> <td rowspan="9" style="writing-mode: vertical-rl; transform: rotate(180deg);">Your Casters & Forks</td> <td>3"Caster & STD Forks</td> <td><input type="checkbox"/>*</td> <td><input type="checkbox"/>*</td> <td><input type="checkbox"/></td> <td><input type="checkbox"/></td> <td><input type="checkbox"/></td> <td><input type="checkbox"/></td> <td><input type="checkbox"/></td> <td><input type="checkbox"/></td> </tr> <tr> <td>3"Caster & Springs</td> <td></td> <td><input type="checkbox"/>*</td> <td><input type="checkbox"/></td> <td><input type="checkbox"/></td> <td><input type="checkbox"/></td> <td><input type="checkbox"/></td> <td><input type="checkbox"/></td> <td><input type="checkbox"/></td> </tr> <tr> <td>3"Caster & Frog Legs</td> <td></td> <td></td> <td></td> <td><input type="checkbox"/>*</td> <td><input type="checkbox"/>*</td> <td><input type="checkbox"/>*</td> <td><input type="checkbox"/>*</td> <td></td> </tr> <tr> <td>4"Caster & STD Forks</td> <td></td> <td><input type="checkbox"/>*</td> <td><input type="checkbox"/>*</td> <td><input type="checkbox"/></td> <td><input type="checkbox"/></td> <td><input type="checkbox"/></td> <td><input type="checkbox"/></td> <td></td> </tr> <tr> <td>4"Caster & Springs</td> <td></td> <td><input type="checkbox"/>*</td> <td><input type="checkbox"/>*</td> <td><input type="checkbox"/></td> <td><input type="checkbox"/></td> <td><input type="checkbox"/></td> <td><input type="checkbox"/></td> <td></td> </tr> <tr> <td>4"Caster & Frog Legs</td> <td></td> <td></td> <td><input type="checkbox"/>*</td> <td><input type="checkbox"/>*</td> <td><input type="checkbox"/>*</td> <td><input type="checkbox"/>*</td> <td><input type="checkbox"/>*</td> <td><input type="checkbox"/>*</td> </tr> <tr> <td>5"Caster & STD Forks</td> <td></td> <td></td> <td><input type="checkbox"/>*</td> <td><input type="checkbox"/>*</td> <td><input type="checkbox"/>*</td> <td><input type="checkbox"/></td> <td><input type="checkbox"/></td> <td><input type="checkbox"/></td> </tr> <tr> <td>5"Caster & Springs</td> <td></td> <td></td> <td></td> <td><input type="checkbox"/>*</td> <td><input type="checkbox"/>*</td> <td><input type="checkbox"/>*</td> <td><input type="checkbox"/>*</td> <td><input type="checkbox"/>*</td> </tr> <tr> <td>5"Caster & Frog Legs</td> <td></td> <td></td> <td></td> <td></td> <td><input type="checkbox"/>*</td> <td><input type="checkbox"/>*</td> <td><input type="checkbox"/>*</td> <td><input type="checkbox"/>*</td> </tr> </tbody> </table>			Front Seat Height								17.5"	18.0"	18.5"	19.0"	19.5"	20.0"	20.5"	21.0"	Your Casters & Forks	3"Caster & STD Forks	<input type="checkbox"/> *	<input type="checkbox"/> *	<input type="checkbox"/>	<input type="checkbox"/>	<input type="checkbox"/>	<input type="checkbox"/>	<input type="checkbox"/>	<input type="checkbox"/>	3"Caster & Springs		<input type="checkbox"/> *	<input type="checkbox"/>	<input type="checkbox"/>	<input type="checkbox"/>	<input type="checkbox"/>	<input type="checkbox"/>	<input type="checkbox"/>	3"Caster & Frog Legs				<input type="checkbox"/> *	<input type="checkbox"/> *	<input type="checkbox"/> *	<input type="checkbox"/> *		4"Caster & STD Forks		<input type="checkbox"/> *	<input type="checkbox"/> *	<input type="checkbox"/>	<input type="checkbox"/>	<input type="checkbox"/>	<input type="checkbox"/>		4"Caster & Springs		<input type="checkbox"/> *	<input type="checkbox"/> *	<input type="checkbox"/>	<input type="checkbox"/>	<input type="checkbox"/>	<input type="checkbox"/>		4"Caster & Frog Legs			<input type="checkbox"/> *	<input type="checkbox"/> *	<input type="checkbox"/> *	<input type="checkbox"/> *	<input type="checkbox"/> *	<input type="checkbox"/> *	5"Caster & STD Forks			<input type="checkbox"/> *	<input type="checkbox"/> *	<input type="checkbox"/> *	<input type="checkbox"/>	<input type="checkbox"/>	<input type="checkbox"/>	5"Caster & Springs				<input type="checkbox"/> *	<input type="checkbox"/> *	<input type="checkbox"/> *	<input type="checkbox"/> *	<input type="checkbox"/> *	5"Caster & Frog Legs					<input type="checkbox"/> *	<input type="checkbox"/> *	<input type="checkbox"/> *	<input type="checkbox"/> *	
				Front Seat Height																																																																																																		
		17.5"	18.0"	18.5"	19.0"	19.5"	20.0"	20.5"	21.0"																																																																																													
Your Casters & Forks	3"Caster & STD Forks	<input type="checkbox"/> *	<input type="checkbox"/> *	<input type="checkbox"/>	<input type="checkbox"/>	<input type="checkbox"/>	<input type="checkbox"/>	<input type="checkbox"/>	<input type="checkbox"/>																																																																																													
	3"Caster & Springs		<input type="checkbox"/> *	<input type="checkbox"/>	<input type="checkbox"/>	<input type="checkbox"/>	<input type="checkbox"/>	<input type="checkbox"/>	<input type="checkbox"/>																																																																																													
	3"Caster & Frog Legs				<input type="checkbox"/> *	<input type="checkbox"/> *	<input type="checkbox"/> *	<input type="checkbox"/> *																																																																																														
	4"Caster & STD Forks		<input type="checkbox"/> *	<input type="checkbox"/> *	<input type="checkbox"/>	<input type="checkbox"/>	<input type="checkbox"/>	<input type="checkbox"/>																																																																																														
	4"Caster & Springs		<input type="checkbox"/> *	<input type="checkbox"/> *	<input type="checkbox"/>	<input type="checkbox"/>	<input type="checkbox"/>	<input type="checkbox"/>																																																																																														
	4"Caster & Frog Legs			<input type="checkbox"/> *	<input type="checkbox"/> *	<input type="checkbox"/> *	<input type="checkbox"/> *	<input type="checkbox"/> *	<input type="checkbox"/> *																																																																																													
	5"Caster & STD Forks			<input type="checkbox"/> *	<input type="checkbox"/> *	<input type="checkbox"/> *	<input type="checkbox"/>	<input type="checkbox"/>	<input type="checkbox"/>																																																																																													
	5"Caster & Springs				<input type="checkbox"/> *	<input type="checkbox"/> *	<input type="checkbox"/> *	<input type="checkbox"/> *	<input type="checkbox"/> *																																																																																													
	5"Caster & Frog Legs					<input type="checkbox"/> *	<input type="checkbox"/> *	<input type="checkbox"/> *	<input type="checkbox"/> *																																																																																													
8. REAR SEAT HEIGHT	<input type="checkbox"/> 15.0" <input type="checkbox"/> 15.5" <input type="checkbox"/> 16.0" <input type="checkbox"/> 16.5" <input type="checkbox"/> 17.0" <input type="checkbox"/> 17.5" <input type="checkbox"/> 18.0" <input type="checkbox"/> 18.5" <input type="checkbox"/> 19.0"	\$ STD																																																																																																				
Rear Seat Height Ranges The rear seat heights are impacted by the size of your Tires.	<table border="1" style="width:100%; border-collapse: collapse;"> <thead> <tr> <th>Rear Tire Size</th> <th>Rear Seat Height</th> </tr> </thead> <tbody> <tr> <td>24"x1"(540)</td> <td>15.0"- 18.0"</td> </tr> <tr> <td>24"x1 3/8"(540)</td> <td>15.5"- 18.0"</td> </tr> <tr> <td>25"x1"(559)</td> <td>16.0"- 18.0"</td> </tr> <tr> <td>24"x2"(540)</td> <td>16.0"- 18.5"</td> </tr> <tr> <td>26"x1"(590)</td> <td>16.0"- 19.0"</td> </tr> <tr> <td>25"x1.95"(559)</td> <td>16.5"- 19.0"</td> </tr> </tbody> </table>	Rear Tire Size	Rear Seat Height	24"x1"(540)	15.0"- 18.0"	24"x1 3/8"(540)	15.5"- 18.0"	25"x1"(559)	16.0"- 18.0"	24"x2"(540)	16.0"- 18.5"	26"x1"(590)	16.0"- 19.0"	25"x1.95"(559)	16.5"- 19.0"																																																																																							
Rear Tire Size	Rear Seat Height																																																																																																					
24"x1"(540)	15.0"- 18.0"																																																																																																					
24"x1 3/8"(540)	15.5"- 18.0"																																																																																																					
25"x1"(559)	16.0"- 18.0"																																																																																																					
24"x2"(540)	16.0"- 18.5"																																																																																																					
26"x1"(590)	16.0"- 19.0"																																																																																																					
25"x1.95"(559)	16.5"- 19.0"																																																																																																					
9. CENTER OF GRAVITY	<input type="checkbox"/> 2.0" <input type="checkbox"/> 2.5" <input type="checkbox"/> 3.0" <input type="checkbox"/> 3.5" <input type="checkbox"/> 4.0" <input type="checkbox"/> 4.5"	\$ STD																																																																																																				
<input type="checkbox"/> Amputee Axle Plate		\$ 123																																																																																																				
10. CAMBER ANGLE	<input type="checkbox"/> 0° <input type="checkbox"/> 2° <input type="checkbox"/> 4° <input type="checkbox"/> 6° <input type="checkbox"/> 8°	\$ STD																																																																																																				
11. FRONT OF SEAT SLING TO FOOTREST	★ <input type="checkbox"/> 15.5" ★ <input type="checkbox"/> 16.0" ★ <input type="checkbox"/> 16.5" <input type="checkbox"/> 17.0" <input type="checkbox"/> 17.5" <input type="checkbox"/> 18.0" <input type="checkbox"/> 18.5" <input type="checkbox"/> 19.0" <small>★ Not Available w/ 19.0", 19.5", 20.0", 20.5", 21.0" Front Seat Height</small> <small>*Measurement must be 2.0" shorter than your Front Seat Height</small>	\$ STD																																																																																																				
HIGH MOUNT <input type="checkbox"/> 11.0" <input type="checkbox"/> 11.5" <input type="checkbox"/> 12.0" <input type="checkbox"/> 12.5" <input type="checkbox"/> 13.0" <input type="checkbox"/> 13.5" <input type="checkbox"/> 14.0" <input type="checkbox"/> 14.5" <input type="checkbox"/> 15.0" <input type="checkbox"/> 15.5" <input type="checkbox"/> 16.0" <input type="checkbox"/> 16.5" <small>With Risers or Clamps</small>		\$ 86																																																																																																				
12. INSIDE WHEEL CLEARANCE	<input type="checkbox"/> 3/4" ★ <input type="checkbox"/> 1" <input type="checkbox"/> 1 1/4" <input type="checkbox"/> 1 1/2" <input type="checkbox"/> 1 3/4" <input type="checkbox"/> 2"	\$ STD																																																																																																				
	<small>★3/4" Inside wheel clearance not available with 2 degree camber.</small>																																																																																																					
NOTE	Eclipse is a custom made wheelchair. If you would like to customize your Eclipse beyond what is available on this order form please submit your request here. Colours will determine as to whether this request can be accomplished while maintaining the safety and integrity of the wheelchair. If it can be accomplished the quote will reflect any and all custom charges, thank you.																																																																																																					

1. SEAT WIDTH

Measure from outside of seat tube to the outside of the opposite seat tube.

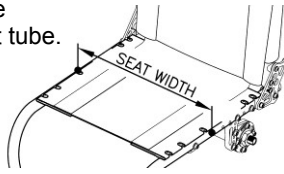

2. SEAT DEPTH

Measure from at the front bottom of backrest tube to the front edge of seat sling.

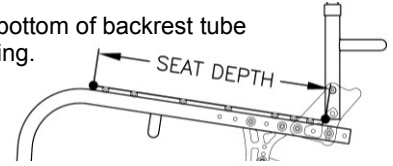

3. FOOTREST WIDTH

Measure from inside of front frame tube to inside of opposite front frame tube.

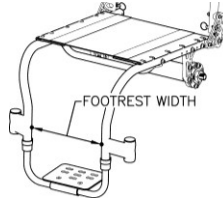

4. FRAME ANGLE

Measure angle frame front to floor.

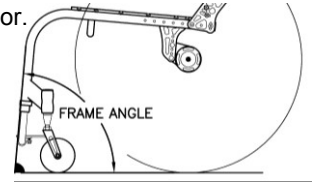

5. BACKREST HEIGHT

Measure from top of back post to seat sling at front bottom of backrest tube.

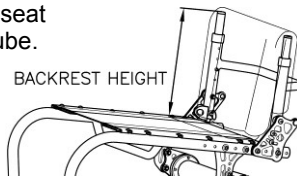

6. BACKREST ANGLE

Measure angle from front of back post to floor.

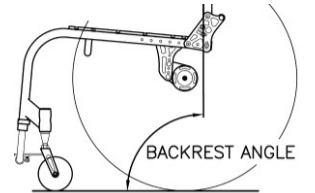

7. FRONT SEAT HEIGHT

Measure from floor to top of seat sling at front edge.

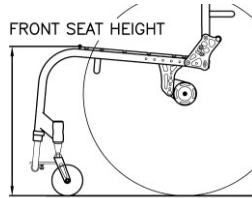

8. REAR SEAT HEIGHT

Measure from floor to top of seat sling at front bottom of backrest tube.

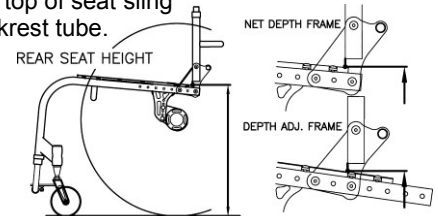

9. CENTER OF GRAVITY

Measure from center of back tube at the folding pivot to the center of the rear axle.

(If welding backrest is selected, Measure from center of back tube at the seat tube to the center of the rear axle.)

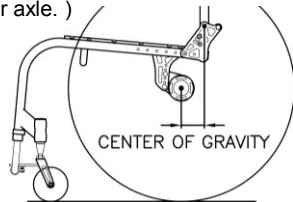

10. CAMBER ANGLE

Measure angle from wheel to vertical at floor.

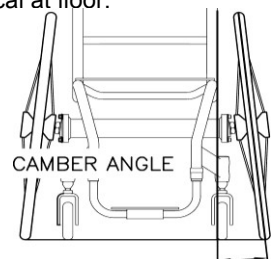

11. FRONT OF SEAT SLING TO FOOTREST

ADULT CHAIR

Measure from top of seat sling at front edge to top of foot plate at front edge.

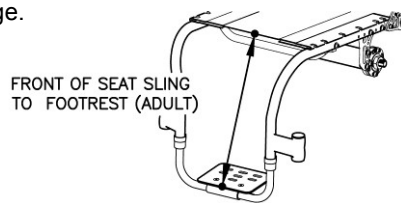

PEDIATRIC CHAIR

Measure vertical from top of seat sling at front edge to top of foot plate.





12. INSIDE WHEEL CLEARANCE

Measure from outside of seat back tube to inside of rear tire.

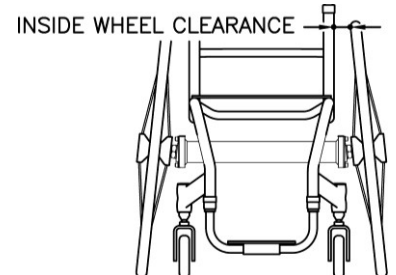
(If side guards are selected, measure from outside of side guards to inside of rear tire.)

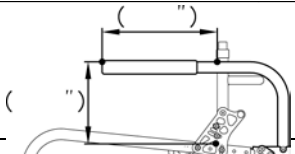
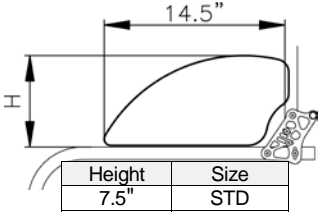

C COMPONENTS

WHEEL LOCKS			
<input type="checkbox"/> New Solution Push to Lock	<input type="checkbox"/> w/ 2" Extension Handle (\$92 up charge)		\$ STD
<input type="checkbox"/> Gallop Push to Lock / Anodized			\$ STD
<input type="checkbox"/> PRIMO Push To Lock			\$ 140
<input type="checkbox"/> Question Mark Style Scissor			\$ 150
<input type="checkbox"/> NEW Compact Scissor Lock / Anodized Black Only			\$ 280
<input type="checkbox"/> Gallop Scissor Lock / Anodized			\$ 280
PUSH HANDLES *If you are ordering push handles, You must select the backrest locking mechanism.			
<input type="checkbox"/> Integrated w/Fixed Backrest Height / Anodized Black Only			\$ STD
<input type="checkbox"/> Bolt-on / Anodized Black Only Specify Height from floor -()			\$ 220
<input type="checkbox"/> Bolt-on w/Quick Release / Anodized Black Only Specify Height from floor -()			\$ 320
<input type="checkbox"/> NEW Height Adj. / Anodized Black Only Specify Maximum height from floor -()			\$ 390
NEW ARM RESTS Anodized Black Only			
<input type="checkbox"/> Fixed Tubular Armrest	Adj. Angle and Height	Height from seat sling Set at : <input type="checkbox"/> 8" <input type="checkbox"/> 9" <input type="checkbox"/> 10" <input type="checkbox"/> 11"	E0973 \$ 450
<input type="checkbox"/> Swing Away Tubular Armrest	Adj. Angle and Height	Height from seat sling Set at : <input type="checkbox"/> 8" <input type="checkbox"/> 9" <input type="checkbox"/> 10" <input type="checkbox"/> 11"	E0973 \$ 450
<input type="checkbox"/> Flip-Up Armrest	<input type="checkbox"/> w/Fixed Tubular Armrest	Height from seat sling Set at : <input type="checkbox"/> 8" <input type="checkbox"/> 9" <input type="checkbox"/> 10" <input type="checkbox"/> 11" <input type="checkbox"/> 12"	E0973 \$ 450
	Adj. Angle <input type="checkbox"/> w/ Swing Away Tubular Armrest	Height from seat sling Set at : <input type="checkbox"/> 8" <input type="checkbox"/> 9" <input type="checkbox"/> 10" <input type="checkbox"/> 11" <input type="checkbox"/> 12"	E0973 \$ 450
<input type="checkbox"/> Custom Length & Height (\$173 up charge)			
*Specify Height & Length →			
ANTI-TIPPERS			
<input type="checkbox"/> Press Release Removable Anti-tipper(pair)			E0971 \$ 330
SIDE GUARDS			
<input type="checkbox"/> Rigid Side Guards - Black ABS	<input type="checkbox"/> Non-Removable <input type="checkbox"/> Removable <input type="checkbox"/> Removable w/Hole (\$14 up charge)		\$ 260
Color: Black Only	Size: <input type="checkbox"/> STD <input type="checkbox"/> Medium <input type="checkbox"/> Cut to Wheel (\$100 up charge) Measurement		
<input type="checkbox"/> Rigid Side Guards - Aluminum	<input type="checkbox"/> Non-Removable <input type="checkbox"/> Removable		\$ 420
	Size: <input type="checkbox"/> Medium Only <input type="checkbox"/> Cut to Wheel (\$100 up charge) Measurement		
	Color <input type="checkbox"/> Black (STD) <input type="checkbox"/> Pol. Aluminum (STD)		
	<input type="checkbox"/> Powder Coated () (\$140 up charge)		
	<input type="checkbox"/> Gold Plate (+CFP)		
			
<input type="checkbox"/> Fabric Clothing Guards Black Nylon w/Velcro			\$ 200
SEAT CUSHION *-Please see section F for other cushion choices.-			
<input type="checkbox"/> Foam Cushion w/Nylon Black Cover		Thickness <input type="checkbox"/> 1" <input type="checkbox"/> 2" <input type="checkbox"/> 3" <input type="checkbox"/> 4"	\$ CFP
<input type="checkbox"/> Custom Cushion Cover (Std. Foam Cushion Only) -Select Fabric ()			(\$104 up charge)
ACCESSORIES			
<input type="checkbox"/> Frame Protectors / Black Leather/Zipper Type			\$ 150
<input type="checkbox"/> Gel Ovation Protector Wraps Gel Silicone		<input type="checkbox"/> Short (1/2") <input type="checkbox"/> Long (3")	\$ 200
<input type="checkbox"/> E0978 Padded Seat Belt w/Auto Buckle Black Belt Only			E0978 \$ 113
<input type="checkbox"/> Tie Down Brackets 4pcs.		<input type="checkbox"/> Bolted <input type="checkbox"/> Welded	\$ 400
<input type="checkbox"/> Calf Strap <input type="checkbox"/> Black <input type="checkbox"/> Matching Fabric (\$65 up charge) -Select Fabric ()			\$ 35
<input type="checkbox"/> Bodypoint Padded Calf Strap		<input type="checkbox"/> (14"-16" footrest width) \$89 <input type="checkbox"/> (16"-20" footrest width) \$95 <input type="checkbox"/> (20"-24") \$102	
<input type="checkbox"/> Hanging Zipper Pouch <input type="checkbox"/> Black <input type="checkbox"/> Matching Fabric (\$75) or <input type="checkbox"/> Leather (\$80) Custom Size Width: Length:			\$ 120
<input type="checkbox"/> Matching Fabric on Padded Side Guards -Select Fabric ()			\$ 278
UPHOLSTERY CHOICE & COLOR *Positioning Back Available. Please see Section E			
<input type="checkbox"/> Standard Adjustable Height Backrest (Black)			\$ STD
<input type="checkbox"/> Adjustable Tension Backrest Black Only (*Not available with 8" Backrest Height)			\$ 300
Options	<input type="checkbox"/> Fun Fabric: For Std. or Adj. Style (Choose From Choices on Page 6 and write below) (\$ 92 up charge)		
	<input type="checkbox"/> Backrest Leather Trim (outside panels) (\$ up charge)		\$ CFP

FABRIC CHOICE SHEET

1. Camouflage Girls

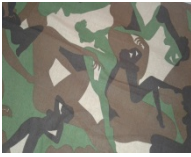

2. Purple Zebra



3. Silver Grey Snake

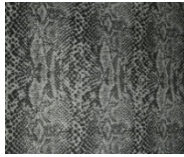

5. Laughing Skulls



6. Purple Snake



7. Sweetheart Pinup Girls



9. Blue Flames

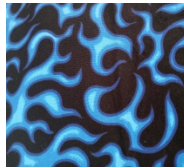

10. Arctic Camo



11. Furry Friends



12. Supercars



13. Urban Camo

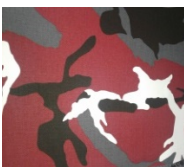

14. Superbikes



15. Sizzle Flames



16. Hot Rod Flames



17. Skulls w/ Attitude

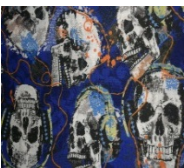

18. Sweet Pink



19. Heart and Soul



20. Home Run



21. Fuzzy Giraffe

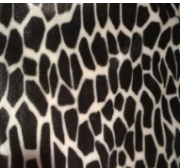

22. Cheetah



23. Paperweight Cobalt



24. Zig Zag Dots



25. Smokey Tribal Flames

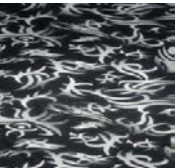

26. Rose and Rebellion



27. Tattoo Adventure(Cream



28. Red Tribal Flames

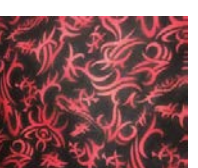

29. Tattoo Adventure(Black)

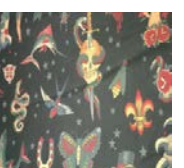

30. Butterfly Bandana

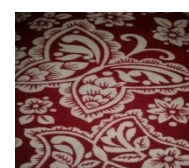

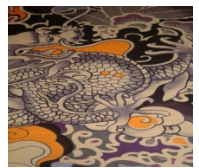

31. Tatsu Dragon



D TIRES ,CASTERS, & FORKS

TIRES						
<input type="checkbox"/> Primo High Pressure Tire <input type="checkbox"/> 24"x1" <input type="checkbox"/> 25"x1" <input type="checkbox"/> 26"x1" Gray Tire w/ black line						E2211/E2212 \$ STD
<input type="checkbox"/> Primo High Pressure Tire <input type="checkbox"/> 24"x1" <input type="checkbox"/> 25"x1" or <input type="checkbox"/> 26"x1" <input type="checkbox"/> Blue <input type="checkbox"/> Red						E2211/E2212 \$ 100
<input type="checkbox"/> Low Pressure Tire <input type="checkbox"/> 24"x1-3/8" or <input type="checkbox"/> 26"x1-3/8" Gray Only						E2211/E2212 \$ STD
<input type="checkbox"/> Schwalbe Marathon Plus High Pressure Tire <input type="checkbox"/> 24"x1", <input type="checkbox"/> 25"x1" or <input type="checkbox"/> 26"x1" Black Only						E2211/E2212 \$ 170
<input type="checkbox"/> Solid Tire <input type="checkbox"/> 24"x1" <input type="checkbox"/> 25"x1" <input type="checkbox"/> 26"x1" Black						E2218 \$ 219
<input type="checkbox"/> Moderate Knobby Tire (EuroTrek) 24"x1-3/8" (37-540) Gray Only						E2211/E2212 \$ 155
<input type="checkbox"/> Kobra Knobby Tire 24"x 2" (50-540) Gray Only <input type="checkbox"/> Blue Line <input type="checkbox"/> Red Line						E2211/E2212 \$ 155
<input type="checkbox"/> Kobra Knobby Tire 26"x 2" (50-559) Gray Only <input type="checkbox"/> Blue Line <input type="checkbox"/> Red Line						E2211/E2212 \$ 155
<input type="checkbox"/> Nevegal Knobby Tire 24" x 2.1"(50-540) Black Only						E2211/E2212 \$ 155
<input type="checkbox"/> Kenda Knobby Tire(Kwick Drumlin) (559) 26" X 1. 75 - 2. 25 Black Only						E2211 \$ 155
<input type="checkbox"/> Flat-Free Inserts For 24"x1-3/8" Tires Only						E2211/E2213 \$ 155
CASTERS						
SIZE	TIRE WIDTH	HUB COLOR	TIRE COLOR	DESCRIPTION		
<input type="checkbox"/> 3"	1"	Black Hub	Black Tire Only	Polyurethane		\$ STD
<input type="checkbox"/> 3"	1"	Plastic Black Hub	Clear Tire Only	Lighted, Polyurethane		\$ 86
<input type="checkbox"/> 3"	1"	Red Hub	Red Tire Only	Polyurethane		\$ STD
<input type="checkbox"/> 3"	1"	Black Hub	Clear Tire Only	Polyurethane		\$ STD
<input type="checkbox"/> 3"	1"	Aluminum Silver Hub	Black Tire Only	Made By Frog Legs		\$ 209
<input type="checkbox"/> 3"	1"	Aluminum Black Hub	Black Tire Only	Made By Frog Legs		\$ 209
<input type="checkbox"/> 3"	1.5"	Aluminum Silver Hub	Black Tire Only	Soft Roll Made By Frog Legs		\$ 209
<input type="checkbox"/> 3"	1.5"	Aluminum Black Hub	Black Tire Only	Soft Roll Made By Frog Legs		\$ 209
<input type="checkbox"/> 4"	1 1/8"	Plastic Black Hub	Black Tire Only	Polyurethane E2222		\$ STD
<input type="checkbox"/> 4"	1"	Plastic Black Hub	Clear Only	Lighted, Polyurethane		\$ 86
<input type="checkbox"/> 4"	1"	Aluminum Silver Hub	Black Tire Only	Made By Frog Legs		\$ 209
<input type="checkbox"/> 4"	1"	Aluminum Black Hub	Black Tire Only	Made By Frog Legs		\$ 209
<input type="checkbox"/> 4"	1.5"	Aluminum Silver Hub	Tire <input type="checkbox"/> Black <input type="checkbox"/> Blue <input type="checkbox"/> Red	Soft Roll Made By Frog Legs		\$ 209
<input type="checkbox"/> 4"	1.5"	Aluminum Black Hub	Black Tire Only	Soft Roll Made By Frog Legs		\$ 209
<input type="checkbox"/> 5"	1"	Composite Black Hub	Black Tire Only	Polyurethane		\$ STD
<input type="checkbox"/> 5"	1"	Plastic Black Hub	Clear Tire Only	Lighted, Polyurethane		\$ 86
<input type="checkbox"/> 5"	1"	Aluminum Silver Hub	Black Tire Only	Made By Frog Legs		\$ 209
<input type="checkbox"/> 5"	1"	Aluminum Black Hub	Black Tire Only	Made By Frog Legs		\$ 209
<input type="checkbox"/> 5"	1.5"	Aluminum Silver Hub	Tire <input type="checkbox"/> Black <input type="checkbox"/> Blue <input type="checkbox"/> Red	Soft Roll Made By Frog Legs		\$ 209
<input type="checkbox"/> 5"	1.5"	Aluminum Black Hub	Black Tire Only	Soft Roll Made By Frog Legs		\$ 209
<input type="checkbox"/> 6"	1.5"	Aluminum Black Hub	Black Tire Only	Soft Roll Made By Frog Legs		\$ 234
<input type="checkbox"/> 6"	1.5"	Aluminum Silver Hub	Black Tire Only	Soft Roll Made By Frog Legs		\$ 234
<input type="checkbox"/>	<input type="checkbox"/> 1"OR <input type="checkbox"/> 1.5"	Hub Color:	Tread Color:	Soft Roll Made By Frog Legs		\$ CFP
FORKS						
<input type="checkbox"/> Frog Leg Shields(4 pcs) Only For FrogLeg Forks						30
<input type="checkbox"/> STD Aluminum Forks Black Only						\$ STD
Extra Options for Aluminum Forks <input type="checkbox"/> With Suspension Springs						E1015 \$ 72
<input type="checkbox"/> With Quick Release Axles						K0073 \$ 141
<input type="checkbox"/> Frog Leg Suspension Forks 1" Wide (For 3", 4" x 1" width Caster and 5" STD Caster, 5" lighted Caster) (Not available with Quick Release Axle)						
*User's Weight _____ Color <input type="checkbox"/> Anodized Black <input type="checkbox"/> Anodized Silver						E1015 \$ 607
<input type="checkbox"/> Frog Leg Suspension Forks 1.5" Wide (For 3", 4" x 1.5" width Caster and 5" x 1"& 5" x 1.5" Casters) (Not available with Quick Release Axle)						
*User's Weight _____ Color <input type="checkbox"/> Anodized Black <input type="checkbox"/> Anodized Silver						E1015 \$ 607

F WHEELS

WHEELS																		
Wire Wheels	<input type="checkbox"/> 24" (540)		\$ NCO															
	<input type="checkbox"/> 25" (559)	\$ NCO															
	<input type="checkbox"/> 26" (590)		\$ NCO															
Y-360 Billet Wheels *Max. Capacity 220Lbs *Camber 0-2° max *Not for Sports or Rugged use	<input type="checkbox"/> 25" (559) Style <input type="checkbox"/> Saw Blade		\$ 1,495															
Y-360 Billet Wheels MOD Style *Max. Capacity 220Lbs *Camber 0-2° max *Not for Sports or Rugged use	<input type="checkbox"/> 25" (559) Only Style <input type="checkbox"/> Tribal Sun <input type="checkbox"/> Girls <input type="checkbox"/> Eagle <input type="checkbox"/> Holy Cross <input type="checkbox"/> Hono(Flames) Specify Powder Coat Color for Insert Only () *Choose from Frame Colors		\$ 1,783															
Extra Options for		<input type="checkbox"/> Powder-Coated Spokes Only () *Choose from Frame Colors	(\$250 up charge)															
Spinergy Spox 18 Spokes 	<input type="checkbox"/> 24" (540) <input type="checkbox"/> 25" (559) <input type="checkbox"/> 26" (590) Spoke Color <input type="checkbox"/> Black With Silver Hub <input type="checkbox"/> Red With Black Hub <input type="checkbox"/> Yellow With Black Hub <input type="checkbox"/> Blue With Black Hub <input type="checkbox"/> White With Black Hub		\$ 1,100															
	<input type="checkbox"/> Custom Color Spoke Pattern	<table border="1"> <thead> <tr> <th colspan="2"></th> <th>Left Wheel</th> <th>Right Wheel</th> </tr> </thead> <tbody> <tr> <td>Spokes</td> <td>Inside</td> <td></td> <td></td> </tr> <tr> <td>Color</td> <td>Outside</td> <td></td> <td></td> </tr> <tr> <td>Hub Color</td> <td></td> <td><input type="checkbox"/> Black/<input type="checkbox"/> Silver</td> <td><input type="checkbox"/> Black/<input type="checkbox"/> Silver</td> </tr> </tbody> </table>			Left Wheel	Right Wheel	Spokes	Inside			Color	Outside			Hub Color		<input type="checkbox"/> Black/ <input type="checkbox"/> Silver	<input type="checkbox"/> Black/ <input type="checkbox"/> Silver
		Left Wheel	Right Wheel															
Spokes	Inside																	
Color	Outside																	
Hub Color		<input type="checkbox"/> Black/ <input type="checkbox"/> Silver	<input type="checkbox"/> Black/ <input type="checkbox"/> Silver															
Spinergy LX 12 Spokes 	<input type="checkbox"/> 24" (540) <input type="checkbox"/> 25" (559) <input type="checkbox"/> 26" (590) Spoke Color <input type="checkbox"/> Black With Silver Hub <input type="checkbox"/> Red With Black Hub <input type="checkbox"/> Yellow With Black Hub <input type="checkbox"/> Blue With Black Hub <input type="checkbox"/> White With Black Hub <input type="checkbox"/> Neon Green With Black Hub <input type="checkbox"/> Pink With Black Hub <input type="checkbox"/> Orange With Black Hub <input type="checkbox"/> Purple With Black Hub		\$ 1,252															
	<input type="checkbox"/> Custom Color Spoke Pattern	<table border="1"> <thead> <tr> <th colspan="2"></th> <th>Left Wheel</th> <th>Right Wheel</th> </tr> </thead> <tbody> <tr> <td>Spokes</td> <td>Inside</td> <td></td> <td></td> </tr> <tr> <td>Color</td> <td>Outside</td> <td></td> <td></td> </tr> <tr> <td>Hub Color</td> <td></td> <td><input type="checkbox"/> Black/<input type="checkbox"/> Silver</td> <td><input type="checkbox"/> Black/<input type="checkbox"/> Silver</td> </tr> </tbody> </table>			Left Wheel	Right Wheel	Spokes	Inside			Color	Outside			Hub Color		<input type="checkbox"/> Black/ <input type="checkbox"/> Silver	<input type="checkbox"/> Black/ <input type="checkbox"/> Silver
		Left Wheel	Right Wheel															
Spokes	Inside																	
Color	Outside																	
Hub Color		<input type="checkbox"/> Black/ <input type="checkbox"/> Silver	<input type="checkbox"/> Black/ <input type="checkbox"/> Silver															
Spinergy X-Laced Sport Lite Extreme "XSLX" 24 Spokes 	<input type="checkbox"/> 24" (540) <input type="checkbox"/> 25" (559) <input type="checkbox"/> 26" (590) Spoke Color <input type="checkbox"/> Black With Silver Hub <input type="checkbox"/> Red With Black Hub <input type="checkbox"/> Yellow With Black Hub <input type="checkbox"/> Blue With Black Hub <input type="checkbox"/> White With Black Hub <input type="checkbox"/> Neon Green With Black Hub <input type="checkbox"/> Pink With Black Hub <input type="checkbox"/> Orange With Black Hub <input type="checkbox"/> Purple With Black Hub		\$ 1,380															
	<input type="checkbox"/> Custom Color Spoke Pattern	<table border="1"> <thead> <tr> <th colspan="2"></th> <th>Left Wheel</th> <th>Right Wheel</th> </tr> </thead> <tbody> <tr> <td>Spokes</td> <td>Inside</td> <td></td> <td></td> </tr> <tr> <td>Color</td> <td>Outside</td> <td></td> <td></td> </tr> <tr> <td>Hub Color</td> <td></td> <td><input type="checkbox"/> Black/<input type="checkbox"/> Silver</td> <td><input type="checkbox"/> Black/<input type="checkbox"/> Silver</td> </tr> </tbody> </table>			Left Wheel	Right Wheel	Spokes	Inside			Color	Outside			Hub Color		<input type="checkbox"/> Black/ <input type="checkbox"/> Silver	<input type="checkbox"/> Black/ <input type="checkbox"/> Silver
		Left Wheel	Right Wheel															
Spokes	Inside																	
Color	Outside																	
Hub Color		<input type="checkbox"/> Black/ <input type="checkbox"/> Silver	<input type="checkbox"/> Black/ <input type="checkbox"/> Silver															

Valid from 2024 Prices & Specifications Are Subject To Change Without Notice.

Spinergy Sport Lite Extreme "SLX" 24 Spoke



24" (540) 25" (559) 26" (590)
 Spoke Color Black Red Yellow Blue
 With Silver Hub With Black Hub With Black Hub With Black Hub
 White Neon Green Pink Orange Purple
 With Black Hub With Black Hub With Black Hub With Black Hub With Black Hub

Custom Color Spoke Pattern

		Left Wheel	Right Wheel
Spokes	Inside		
	Outside		
Hub Color		<input type="checkbox"/> Black/ <input type="checkbox"/> Silver	<input type="checkbox"/> Black/ <input type="checkbox"/> Silver

\$ 1,220

\$ 1,330

Spinergy Lite Extreme "XLX" X-Laced-12 Spoke



24" (540) 25" (559) 26" (590)
 Spoke Color Black Red Yellow Blue
 With Silver Hub With Black Hub With Black Hub With Black Hub
 White Neon Green Pink Orange Purple
 With Black Hub With Black Hub With Black Hub With Black Hub With Black Hub

Custom Color Spoke Pattern

		Left Wheel	Right Wheel
Spokes	Inside		
	Outside		
Hub Color		<input type="checkbox"/> Black/ <input type="checkbox"/> Silver	<input type="checkbox"/> Black/ <input type="checkbox"/> Silver

\$ 1,290

\$ 1,400

Spinergy Blade "LXL" 18 Spoke



24" (540) 25" (559) 26" (590)
 Spoke Color Black Red Yellow Blue
 With Silver Hub With Black Hub With Black Hub With Black Hub
 White Neon Green Pink Orange Purple
 With Black Hub With Black Hub With Black Hub With Black Hub With Black Hub

Custom Color Spoke Pattern

		Left Wheel	Right Wheel
Spokes	Inside		
	Outside		
Hub Color		<input type="checkbox"/> Black	<input type="checkbox"/> Black

\$ 1,220

\$ 1,330

Type	<input type="checkbox"/> Standard For 24", 25" or 26" Wheel Anodized Black <input type="checkbox"/> Polish Upcharge \$450	\$	STD
	<input type="checkbox"/> Standard Handrim For 25" Y-360 Billet Wheel Anodized Black <input type="checkbox"/> Polish Upcharge \$450	\$	STD
	<input type="checkbox"/> Vinyl Coated For 24", 25" & 26" Wheels Not available with Y-360 Billet Wheels	\$	200
	<input type="checkbox"/> Spinergy Silver Brushed Anodized For 24", 25" & 26" Not available with Y-360 Billet Wheels	\$	220
	<input type="checkbox"/> Natural Fit For 24", 25" & 26" Wheel		
	<input type="checkbox"/> Standard Grip (Not available with short tabs.) Not available with Y-360 Billet Wheels	\$	570
	<input type="checkbox"/> Super Grip (Not available with short tabs.) Not available with Y-360 Billet Wheels	\$	645
	<input type="checkbox"/> Without Thumb Grip (Not available with Y-360 Billet Wheels)	\$	338
	<input type="checkbox"/> Natural Fit(LT) For 24", 25" & 26" Wheel		
	<input type="checkbox"/> Standard Grip (Not available with short tabs.) Not available with Y-360 Billet Wheels	\$	629
<input type="checkbox"/> Super Grip (Not available with short tabs.) Not available with Y-360 Billet Wheels	\$	706	
<input type="checkbox"/> Without Thumb Grip (Not available with Y-360 Billet Wheels)	\$	400	
<input type="checkbox"/> The Surge Handrims * Not available with Y-360 Billet Wheels	\$	553	
<input type="checkbox"/> The Surge Handrims (LT) * Not available with Y-360 Billet Wheels	\$	603	
<input type="checkbox"/> Spinergy Flex Rim Available only on Spinergy LX & XLX	\$	CFP	
<input type="checkbox"/> The Q-Grip Handrims : anti-slip, latex-free, neoprene coating * Not available with Y-360 Billet Wheels	\$	543	
<input type="checkbox"/> OMIT HANDRIMS	\$	NCC	

TAB LENGTH	<input type="checkbox"/> Long Tab (STD inside clearance 3/4") Not available with Y-360 Billet Wheels *	\$	STD
	<input type="checkbox"/> Short Tab (Inside clearance 1/2") * Not available with Natural Fit Handrim with thumb grip	\$	STD
	<input type="checkbox"/> Short Tab (Set closest to wheel cut off excess) * Not available with Y-360 wheel	\$	35

G CHAIR OPTIONS 1 / 3

SEAT CUSHION			
SUPRACOR® WHEELCHAIR CUSHIONS *Optimal Positioning for Paraplegics and Quadriplegic. Stimulite® Contoured Cushion- 3.5" HIGH. 3 1/4lbs *Black Upholstery only *Comes with Zipper Pouch <input type="checkbox"/> Extra Sensitive (\$35 up charge) <input type="checkbox"/> Sling Style Bottom (\$52 up charge) <input type="checkbox"/> Custom Size (\$- CFP) W(") x D(") <input type="checkbox"/> Extra Cover (\$120 up charge)		<input type="checkbox"/> W14"xD16" (CD1416) <input type="checkbox"/> W16"xD16" (CD1616) <input type="checkbox"/> W16"xD18" (CD1618) <input type="checkbox"/> W18"xD16" (CD1816) <input type="checkbox"/> W18"xD18" (CD1818) <input type="checkbox"/> W18"xD20" (CD1820) <input type="checkbox"/> W20"xD16" (CD2016) <input type="checkbox"/> W20"xD18" (CD2018) <input type="checkbox"/> W20"xD20" (CD2020)	 E2603 \$ 707 E2603 \$ 707 E2603 \$ 707 E2603 \$ 707 E2603 \$ 707 E2603 \$ 714 E2603 \$ 714 E2603 \$ 714 E2603 \$ 734
Stimulite® Slimline Cushion- 2 3/4" HIGH. 3 lbs *Black Upholstery only <input type="checkbox"/> Extra Sensitive (\$35 up charge) <input type="checkbox"/> Sling Style Bottom (\$52 up charge) <input type="checkbox"/> Custom Size (\$- CFP) W(") x D(") <input type="checkbox"/> Extra Cover (\$86 up charge)		<input type="checkbox"/> W14"xD16" (SM1416) * <input type="checkbox"/> W16"xD16" (SM1616) <input type="checkbox"/> W16"xD18" (SM1618) <input type="checkbox"/> W18"xD18" (SM1818) <input type="checkbox"/> W18"xD20" (SM1820) <input type="checkbox"/> W20"xD16" (SM2016) <input type="checkbox"/> W20"xD18" (SM2018) <input type="checkbox"/> W20"xD20" (SM2020)	 E2603 \$ 446 E2603 \$ 446 E2603 \$ 446 E2603 \$ 446 E2603 \$ 490 E2603 \$ 490 E2603 \$ 490 E2603 \$ 518
Stimulite® Corbee Pediatric- 2" HIGH. 1/2 lb *Black Upholstery only <input type="checkbox"/> Extra Sensitive (\$35 up charge) <input type="checkbox"/> Sling Style Bottom (\$52 up charge) <input type="checkbox"/> Custom Size (\$- CFP) W(") x D(")		<input type="checkbox"/> W10"xD10" (PD1010) <input type="checkbox"/> W12"xD12" (PD1212) <input type="checkbox"/> W14"xD14" (PD1414)	 E2603 \$ 342 E2603 \$ 342 E2603 \$ 342
ROHO WHEELCHAIR CUSHIONS 3.8" lbs <input type="checkbox"/> 4" HIGH PROFILE® QUADTRO SELECT® CUSHION *Black Upholstery . . . <input type="checkbox"/> Extra Cover(\$+100) only.		E2622-2623 \$ 669	
<input type="checkbox"/> Specify Size W(") x D(")			
3 lbs <input type="checkbox"/> 3" MID PROFILE® QUADTRO SELECT® CUSHION *Black Upholstery only . <input type="checkbox"/> Extra Cover(\$+100)		E2622-2623 \$ 669	
<input type="checkbox"/> Specify Size W(") x D(")			
2 lbs <input type="checkbox"/> 2" LOW PROFILE® QUADTRO SELECT® CUSHION *Black Upholstery only . <input type="checkbox"/> Extra Cover (\$+100) . . .		E2622-2623 \$ 669	
<input type="checkbox"/> Specify Size W(") x D(")			
THE CURVE CUSHION - 3" HIGH. *Black Upholstery only <input type="checkbox"/> Extra Cover (\$+ 46)		<input type="checkbox"/> W13"xD13" <input type="checkbox"/> W13"xD14" <input type="checkbox"/> W13"xD15" <input type="checkbox"/> W13"xD16" <input type="checkbox"/> W13"xD17" <input type="checkbox"/> W14"xD14" <input type="checkbox"/> W14"xD15" <input type="checkbox"/> W14"xD16" <input type="checkbox"/> W14"xD17" <input type="checkbox"/> W14"xD18" <input type="checkbox"/> W15"xD14" <input type="checkbox"/> W15"xD15" <input type="checkbox"/> W15"xD16" <input type="checkbox"/> W15"xD17" <input type="checkbox"/> W15"xD18" <input type="checkbox"/> W15"xD19" <input type="checkbox"/> W15"xD20" <input type="checkbox"/> W16"xD14" <input type="checkbox"/> W16"xD15" <input type="checkbox"/> W16"xD16" <input type="checkbox"/> W16"xD17" <input type="checkbox"/> W16"xD18" <input type="checkbox"/> W16"xD19" <input type="checkbox"/> W16"xD20" <input type="checkbox"/> W17"xD15" <input type="checkbox"/> W17"xD16" <input type="checkbox"/> W17"xD17" <input type="checkbox"/> W17"xD18" <input type="checkbox"/> W17"xD19" <input type="checkbox"/> W17"xD20" <input type="checkbox"/> W18"xD15" <input type="checkbox"/> W18"xD16" <input type="checkbox"/> W18"xD17" <input type="checkbox"/> W18"xD18" <input type="checkbox"/> W18"xD19" <input type="checkbox"/> W18"xD20" <input type="checkbox"/> W19"xD16" <input type="checkbox"/> W19"xD17" <input type="checkbox"/> W19"xD18" <input type="checkbox"/> W19"xD19" <input type="checkbox"/> W19"xD20" <input type="checkbox"/> W20"xD16" <input type="checkbox"/> W20"xD17" <input type="checkbox"/> W20"xD18" <input type="checkbox"/> W20"xD19" <input type="checkbox"/> W20"xD20" <input type="checkbox"/> W21"xD16" <input type="checkbox"/> W21"xD17" <input type="checkbox"/> W21"xD18" <input type="checkbox"/> W21"xD19" <input type="checkbox"/> W21"xD20" <input type="checkbox"/> W22"xD16" <input type="checkbox"/> W22"xD17" <input type="checkbox"/> W22"xD18" <input type="checkbox"/> W22"xD19" <input type="checkbox"/> W22"xD20" <input type="checkbox"/> W23"xD16" <input type="checkbox"/> W23"xD17" <input type="checkbox"/> W23"xD18" <input type="checkbox"/> W23"xD19" <input type="checkbox"/> W23"xD20"	\$ 260
			

Valid from 2024 Prices & Specifications Are Subject To Change Without

G CHAIR OPTIONS 2 / 3

SEAT CUSHION

Exgel Kaji Cushion

For Comfortable Sitting To Prevent Pressure Sores

No Custom Sizes

Owl Regular(1.6" Thick)

Incontinence Cover Only

E2603

Extra Cover \$104

Unique OWL shape that fits your body shape and optimizes pressure distribution. The "Owl eye" supports the pelvis with extra exgel material in the area where The pressure is applied. The "slit" is for the tailbone area to reduce the pressure on the area that are most susceptible to pressure.

W14"xD16" \$362

W15"xD16" \$362

W16"xD16" \$362

W18"xD16" \$408



No Custom Sizes

No Custom Sizes

Owl High(3.1" Thick)

Incontinence Cover Only

E2603

Extra Cover \$104

The "hip line" shape fits curves of the hips.

W14"xD16" \$437

W15"xD16" \$437

W16"xD16" \$437

W18"xD16" \$495

W18"xD18" \$495



Owl Contour(3.0" Thick) Cushion

Incontinence Cover Only

E2603

Extra Cover \$104

No Custom Sizes

The Contour has a tapered shaped bottom. Firmer foam is used for stable posture support.

W14"xD16" \$454

W15"xD16" \$454

W16"xD16" \$454

W18"xD16" \$495



E2603 **Owl Deep Contour(4.3" Thick)** Prevents sliding inward and outward.

W14"xD16" \$518 W15"xD16" \$518 W16"xD16" \$518
 W18"xD16" \$558 No Custom Sizes **Extra Cover \$104**



E2603 **Standard Regular(1.4" Thick)** Easy to Use-Flat Style Synthetic leather material on the surface then exgel material is placed to redistribute body pressure. Multilayered high density foam that provides proper immersion. Supports stable sitting posture.

W12" x D12" \$368 W13" x D13" \$368 W14" x D14" \$368 W14" x D16" \$368 W16" x D16" \$368
 W16" x D17" \$368 W17" x D16" \$368 W17" x D17" \$368 W18" x D16" \$391 W18" x D18" \$391
 W18" x D19" \$440 W18" x D20" \$440 W19" x D19" \$440

No Custom Sizes

Extra Cover \$104 Incontinence Cover Only



E2603 **Standard High(2.6" Thick)**- High flat profile for more stability and pressure relief. Suitable for heavier users. Synthetic leather material on the surface then exgel material is placed to redistribute body pressure. Multilayered high density foam that provides proper immersion. Supports stable sitting posture.

*Black Upholstery only

No Custom Sizes

W12" x D12" \$431 W13" x D13" \$ 431 W14" x D14" \$431 W14" x D16" \$ 431 W16" x D16" \$ 431
 W16" x D17" \$431 W17" x D16" \$431 W17" x D17" \$431 W18" x D16" \$460 W18" x D18" \$460
 W18" x D19" \$512 W18" x D20" \$512 W19" x D19" \$512

Extra Cover \$104 Incontinence Cover Only



E2603 **Standard Anti-Thrust (2.6" Thick)**

* No Custom Sizes

Incontinence Cover Only

W16 x D16 \$460

W18 x D16 \$500

W18 x D18 \$500

Prevents Unwanted Forward Movement of lower back and hip bone. Synthetic leather material on the surface then exgel material is placed to redistribute body pressure. Multilayered high density foam that provides proper immersion.

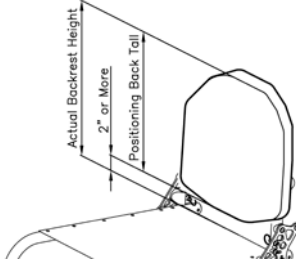

H CHAIR OPTIONS 3/3

		
ADI CARBON BACKREST (Support Contour-ACTIVE 2.5") Mounting Hardware: <input type="checkbox"/> 2 Point Pro <input type="checkbox"/> Quick Release		
Height <input type="checkbox"/> Add Privacy Flap (\$80 up charge)	<input type="checkbox"/> LOW (10" Tall) *Backrest Height requires 12" or more *Available 13"-19" width <input type="checkbox"/> Medium (13" Tall) *Backrest Height requires 15" or more *Available 13"-19" width <input type="checkbox"/> Standard (16" Tall) *Backrest Height requires 18" or more *Available 13"-19" width <input type="checkbox"/> Custom Size (" Tall) x (" width)	Width (") E2613 \$ 986 Width (") E2613 \$ 1,078 Width (") E2613 \$ 1,164 E2613 \$ CFP
ADI ALUMINUM BACKREST (Support Contour-ACTIVE 2.5") Mounting Hardware: <input type="checkbox"/> 2 Point Pro <input type="checkbox"/> Quick Release		
Height <input type="checkbox"/> Add Privacy Flap (\$80 up charge)	<input type="checkbox"/> LOW (10" Tall) *Backrest Height requires 12" or more *Available 10"-20" width <input type="checkbox"/> Medium (13" Tall) *Backrest Height requires 15" or more *Available 12"-20" width <input type="checkbox"/> Standard (16" Tall) *Backrest Height requires 18" or more *Available 14"-20" width <input type="checkbox"/> Tall (18" Tall) *Backrest Height requires 20" or more *Available 16"-20" width <input type="checkbox"/> X-Tall (20" Tall) *Backrest Height requires 22" or more *Available 16"-20" width <input type="checkbox"/> Custom Size (" Tall) x (" width)	Width (") E2613 \$ 807 Width (") E2613 \$ 827 Width (") E2613 \$ 846 Width (") E2613 \$ 866 Width (") E2613 \$ 886 E2613 \$ CFP
ADI ALUMINUM BACKREST (Support Contour-DEEP 4") *Not Available with Lateral Supports Mounting Hardware: <input type="checkbox"/> 2 Point Pro <input type="checkbox"/> Quick Release		
Height <input type="checkbox"/> Add Privacy Flap (\$80 up charge)	<input type="checkbox"/> LOW (10" Tall) *Backrest Height requires 12" or more *Available 10"-20" width <input type="checkbox"/> Medium (13" Tall) *Backrest Height requires 15" or more *Available 12"-20" width <input type="checkbox"/> Standard (16" Tall) *Backrest Height requires 18" or more *Available 14"-20" width <input type="checkbox"/> Tall (18" Tall) *Backrest Height requires 20" or more *Available 16"-20" width <input type="checkbox"/> X-Tall (20" Tall) *Backrest Height requires 22" or more *Available 16"-20" width <input type="checkbox"/> Custom Size (" Tall) x (" width)	Width (") E2615 \$ 940 Width (") E2615 \$ 959 Width (") E2615 \$ 979 Width (") E2615 \$ 998 Width (") E2615 \$ 1,019 E2615 \$ CFP
ADI LATERAL SUPPORTS (Lateral Supports are compatible with only active 2.5" ADI positioning back.)		
<input type="checkbox"/> Stationary Pad	Pad Size <input type="checkbox"/> Small (3" H x 3" D) <input type="checkbox"/> Medium(3" H x 4" D) <input type="checkbox"/> Large(4.5" H x 4.5" D) <input type="checkbox"/> Large(4" H x 6" D) <input type="checkbox"/> Pair <input type="checkbox"/> Left side only or <input type="checkbox"/> Right side only	\$ 422 \$ 211
<input type="checkbox"/> Swing-Out	Pad Size <input type="checkbox"/> Small (3" H x 3" D) <input type="checkbox"/> Medium(3" H x 4" D) <input type="checkbox"/> Large(4.5" H x 4.5" D) <input type="checkbox"/> Large(4" H x 6" D) <input type="checkbox"/> Pair <input type="checkbox"/> Left side only or <input type="checkbox"/> Right side only	\$ 688 \$ 344
OTHER		
<input type="checkbox"/> ADI Transfer Board <input type="checkbox"/> 21" (ADV21) <input type="checkbox"/> 24" (ADV24) <input type="checkbox"/> 29" (ADV29) (ADV29)		\$ 82
<input type="checkbox"/> ADI Push and Transfer Gloves with Leather (one size) (ADGL)		\$ 110
<input type="checkbox"/> ADI Push and Transfer Gloves with Rubber Grip (one size) (ADG)		\$ 110
<input type="checkbox"/> ADI Carbon Solid Seat (Wide: 18" Max, Depth: 20") ※ ONLY AVAILABLE WITH COLOURS NON-REMOVABLE SIDE GUARDS		\$ 827
VARILITE® Seating Systems Available		CFP
Please visit for all options. www.varilite.com		

Valid from 2024 Prices & Specifications Are Subject To Change Without Notice.