

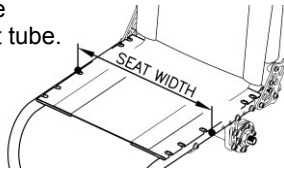

## 1. SEAT WIDTH

Measure from outside of seat tube to the outside of the opposite seat tube.



## 2. SEAT DEPTH

Measure from at the front bottom of backrest tube to the front edge of seat sling.

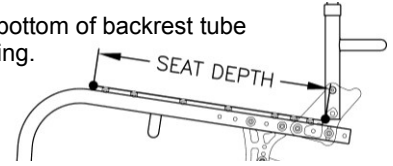

## 3. FOOTREST WIDTH

Measure from inside of front frame tube to inside of opposite front frame tube.

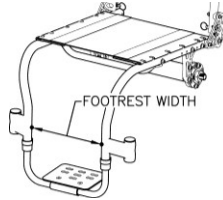

## 4. FRAME ANGLE

Measure angle frame front to floor.

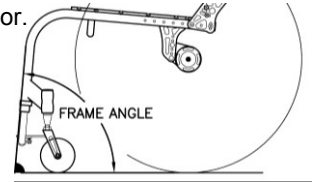

## 5. BACKREST HEIGHT

Measure from top of back post to seat sling at front bottom of backrest tube.

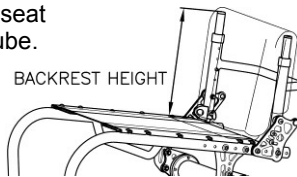

## 6. BACKREST ANGLE

Measure angle from front of back post to floor.

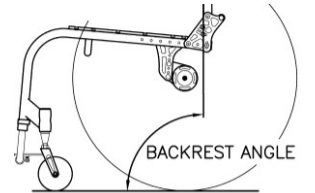

## 7. FRONT SEAT HEIGHT

Measure from floor to top of seat sling at front edge.

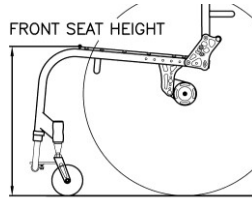

## 8. REAR SEAT HEIGHT

Measure from floor to top of seat sling at front bottom of backrest tube.

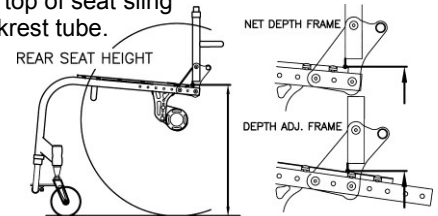

## 9. CENTER OF GRAVITY

Measure from center of back tube at the folding pivot to the center of the rear axle.

( If welding backrest is selected, Measure from center of back tube at the seat tube to the center of the rear axle. )

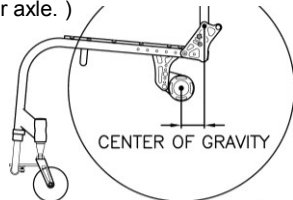

## 10. CAMBER ANGLE

Measure angle from wheel to vertical at floor.

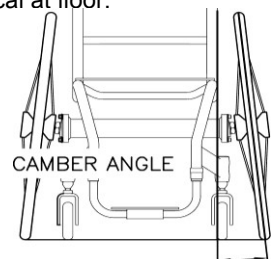

## 11. FRONT OF SEAT SLING TO FOOTREST

### ADULT CHAIR

Measure from top of seat sling at front edge to top of foot plate at front edge.

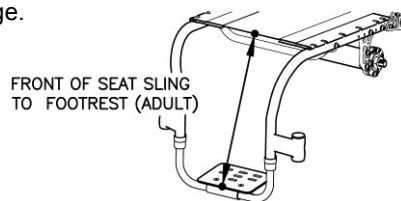

### PEDIATRIC CHAIR

Measure vertical from top of seat sling at front edge to top of foot plate.



## 12. INSIDE WHEEL CLEARANCE

Measure from outside of seat back tube to inside of rear tire.

( If side guards are selected, measure from outside of side guards to inside of rear tire.)

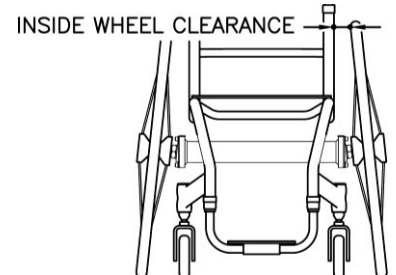

**B SPECIAL PARTS COLORS (Please allow an additional 1-2 weeks delivery)**

**PARTS COLORS**

<b>Powder-Coated</b>	Gloss Black	Twilight Flake	Yellow	Magenta	Fire Engine Red	White
Neon Yellow	Candy Blue	Candy Purple	Candy Green	Candy Red	Candy Raspberry	Cobalt Blue
Brass Metallic	Matte Gray	Matte Purple	Matte Blue	Matte Green	Matte Black	Matte Red
Sparkle Burgundy	Blue Lilac	Neon Green	Orange Sparkle	Mellon Yellow	Gun Smoke Silver	
Tiffany Blue	Shocker Yellow	Granny Sparkle Green	Sparkle Sky Blue	Reed Green		

**Special Colors** Polished Aluminum  
 24 karat Gold Plated \*Please allow an additional 4 weeks delivery

**Please Choose the Color for each Part**

\*Parts not selected will be black color. (Suspension Spring: Silver Color)

\*PC=Powder-Coated

- Foot Plate**
- PC ( ) \$70
  - Polished . . . . \$104
  - Gold Plated . . . \$CFP

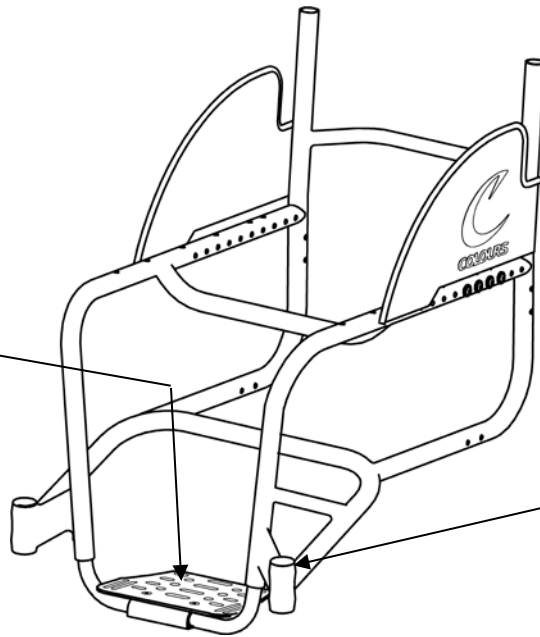

- Caps**
- PC ( ) \$50
  - Polished . . . . N/A
  - Gold Plated . . . N/A

- Upper A-Arms**
- PC ( ) \$138
  - Polished . . . . \$345
  - Gold Plated . . . \$CFP

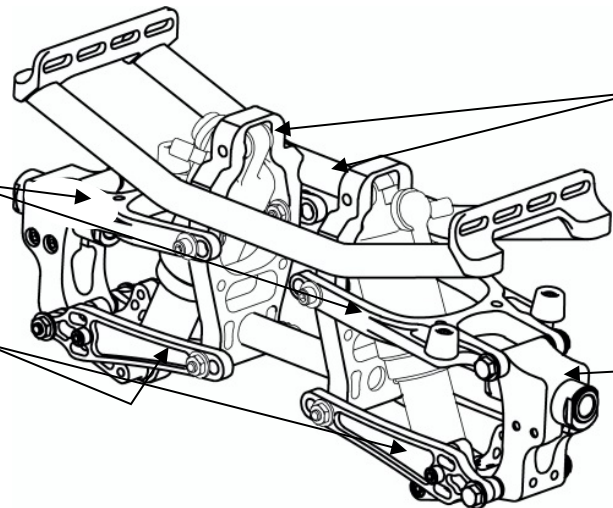

- Suspension Main Frame**
- PC ( ) \$200
  - Polished . . . . \$460
  - Gold Plated . . . \$CFP

- Lower A-Arms**
- PC ( ) \$138
  - Polished . . . . \$322
  - Gold Plated . . . \$CFP

- Axle Receiver Holder**
- PC ( ) \$83
  - Polished . . . . \$207
  - Gold Plated . . . \$CFP

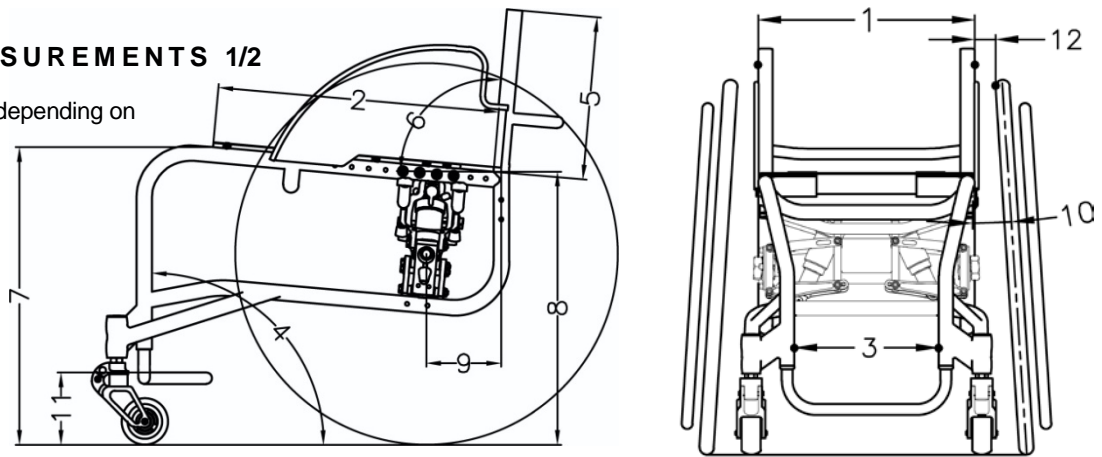

### C FRAME MEASUREMENTS 1/2

\*Frame style may vary depending on measurements.

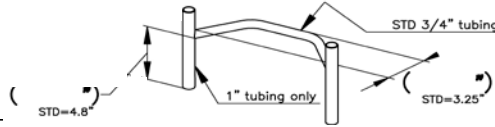
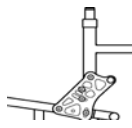

<b>1. SEAT WIDTH</b>	<input type="checkbox"/> 13" <input type="checkbox"/> 14" <input type="checkbox"/> 15" <input type="checkbox"/> 16" <input type="checkbox"/> 17" <input type="checkbox"/> 18" <input type="checkbox"/> 19"	\$	STD
<b>2. SEAT DEPTH</b>	<input type="checkbox"/> 13" <input type="checkbox"/> 14" <input type="checkbox"/> 15" <input type="checkbox"/> 16" <input type="checkbox"/> 17" <input type="checkbox"/> 18" <input type="checkbox"/> 19" . . . . .	\$	STD
	<input type="checkbox"/> <b>Aluminum Seat Pan (Black Only)</b>	\$	324
	<input type="checkbox"/> <b>Positioning Frame</b> Add (   " )	\$	173
<b>3. FOOTREST WIDTH</b>	<input type="checkbox"/> <b>STD</b> (Seat Width Minus 5", Taper on Bottom Frame) . . . . . <input type="checkbox"/> <b>Custom</b> (   " ) Taper on Bottom Frame . . . . . <input type="checkbox"/> <b>Custom</b> (   " ) V - Taper Frame . . . . .	\$	STD NCO NCO
	<div style="display: flex; justify-content: space-around;"> <div style="text-align: center;"> <p>Taper on Bottom Frame</p> <p>Footrest Width</p> </div> <div style="text-align: center;"> <p>V - Taper Frame</p> <p>Footrest Width</p> </div> </div>		
<b>FOOT PLATE STYLE</b>	<input type="checkbox"/> <b>Welded Tubular Loop</b> (not height Adj) . . . . . <input type="checkbox"/> <b>Tubular Loop</b> with adjustable height * <b>Not Available for V-Taper</b> . . . . . <input type="checkbox"/> <b>Welded Single Loop</b> with adjust angle STD Foot Plate . . . . . <input type="checkbox"/> <b>Single Loop</b> with adjust angle & height STD Foot Plate * <b>Not Available for V-Taper Frame</b> . . . . .	\$	STD 331 230 288
<input type="checkbox"/> <b>Add Anti-Skid Tape (\$20 up charge)</b>			
<input type="checkbox"/> <b>Fill Inside of Tubular Loop (\$75 up charge)</b>			
<b>* Must Specify Measurement</b>	<div style="display: flex; justify-content: space-around;"> <div style="text-align: center;"> <p>Welded Tubular Loop</p> </div> <div style="text-align: center;"> <p>Tubular Loop with adjust height Foot Plate</p> </div> <div style="text-align: center;"> <p>Single Loop with adjust angle &amp; height Foot Plate</p> </div> </div> <p><b>Size of Loop</b> ▶ (   " )</p> <p>*Measurement must be 2.5" shorter than your Footrest Width</p> <p><b>Angle or Bucket of Loop</b> ▶ (   " )</p>		
	<input type="checkbox"/> <b>Custom Foot Plate (\$115 up charge)</b> *Available Solid Plate Only (   " ) *Measurement must be 2.5" shorter than your Footrest Width <input type="checkbox"/> <b>ABS Foot Plate (\$86 up charge)</b>		
<b>4. FRAME ANGLE</b>	<input type="checkbox"/> 75° <input type="checkbox"/> 80° <input type="checkbox"/> 85° <input type="checkbox"/> 90° to the ground . . . . . <input type="checkbox"/> <b>Custom</b> (   ° ) to the ground . . . . .	\$	STD NCO

**C FRAME MEASUREMENTS 2/2**

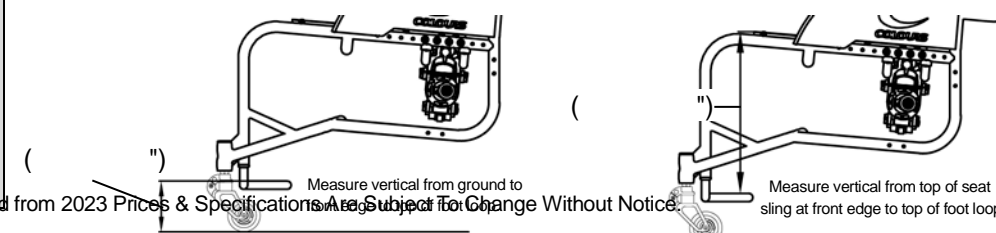
<b>5. BACKREST HEIGHT</b> * Welded Backrest only	<input type="checkbox"/> 8" <input type="checkbox"/> 9" <input type="checkbox"/> 10" <input type="checkbox"/> 11" <input type="checkbox"/> 12" <input type="checkbox"/> 13" <input type="checkbox"/> 14" <input type="checkbox"/> 15" <input type="checkbox"/> 16" <input type="checkbox"/> 17" <input type="checkbox"/> 18"	\$ STD																																																																																	
	<input type="checkbox"/> <b>Custom Backrest</b> .....	\$ 200																																																																																	
																																																																																			
	<input type="checkbox"/> <b>Folding Backrest</b>	\$ 288																																																																																	
	<input type="checkbox"/> <b>Add Locking Mechanism \$163</b>																																																																																		
																																																																																			
<b>SIDE GUARDS</b> ▶ * Welded Side Guards only *Not available with folding backrest	<input type="checkbox"/> <b>Welded Side Guards</b> ..... * Must Specify Measurement ▶	\$ STD																																																																																	
																																																																																			
<b>6. BACKREST ANGLE</b>	(            °) to the ground *STD 90°	\$ STD																																																																																	
<b>7. FRONT SEAT HEIGHT</b>	<input type="checkbox"/> 16.5" <input type="checkbox"/> 17.0" <input type="checkbox"/> 17.5" <input type="checkbox"/> 18.0" <input type="checkbox"/> 18.5" <input type="checkbox"/> 19.0" <input type="checkbox"/> 19.5" <input type="checkbox"/> 20.0" <input type="checkbox"/> 20.5"	\$ STD																																																																																	
<b>8. REAR SEAT HEIGHT</b>	*The rear seat heights are impacted by the size of your rear tire. ....	\$ STD																																																																																	
	<table border="1" style="width:100%; border-collapse: collapse;"> <thead> <tr> <th>Your Rear Tire Size</th> <th colspan="8">Rear Seat Height</th> </tr> </thead> <tbody> <tr> <td>24"x1"(540)</td> <td><input type="checkbox"/>16.0"</td> <td><input type="checkbox"/>16.5"</td> <td><input type="checkbox"/>17.0"</td> <td><input type="checkbox"/>17.5"</td> <td><input type="checkbox"/>18.0"</td> <td><input type="checkbox"/>18.5"</td> <td></td> <td></td> </tr> <tr> <td>24"x1.2"(540)</td> <td></td> <td><input type="checkbox"/>16.5"</td> <td><input type="checkbox"/>17.0"</td> <td><input type="checkbox"/>17.5"</td> <td><input type="checkbox"/>18.0"</td> <td><input type="checkbox"/>18.5"</td> <td><input type="checkbox"/>19.0"</td> <td></td> </tr> <tr> <td>24"x1 3/8"(540)</td> <td></td> <td><input type="checkbox"/>16.5"</td> <td><input type="checkbox"/>17.0"</td> <td><input type="checkbox"/>17.5"</td> <td><input type="checkbox"/>18.0"</td> <td><input type="checkbox"/>18.5"</td> <td><input type="checkbox"/>19.0"</td> <td></td> </tr> <tr> <td>25"x1"(559)</td> <td></td> <td><input type="checkbox"/>16.5"</td> <td><input type="checkbox"/>17.0"</td> <td><input type="checkbox"/>17.5"</td> <td><input type="checkbox"/>18.0"</td> <td><input type="checkbox"/>18.5"</td> <td><input type="checkbox"/>19.0"</td> <td></td> </tr> <tr> <td>25"x1.2"(559)</td> <td></td> <td></td> <td><input type="checkbox"/>17.0"</td> <td><input type="checkbox"/>17.5"</td> <td><input type="checkbox"/>18.0"</td> <td><input type="checkbox"/>18.5"</td> <td><input type="checkbox"/>19.0"</td> <td></td> </tr> <tr> <td>24"x2"(540)</td> <td></td> <td></td> <td><input type="checkbox"/>17.0"</td> <td><input type="checkbox"/>17.5"</td> <td><input type="checkbox"/>18.0"</td> <td><input type="checkbox"/>18.5"</td> <td><input type="checkbox"/>19.0"</td> <td></td> </tr> <tr> <td>26"x1"(590)</td> <td></td> <td></td> <td><input type="checkbox"/>17.0"</td> <td><input type="checkbox"/>17.5"</td> <td><input type="checkbox"/>18.0"</td> <td><input type="checkbox"/>18.5"</td> <td><input type="checkbox"/>19.0"</td> <td></td> </tr> <tr> <td>25"x1.95"(559)</td> <td></td> <td></td> <td></td> <td><input type="checkbox"/>17.5"</td> <td><input type="checkbox"/>18.0"</td> <td><input type="checkbox"/>18.5"</td> <td><input type="checkbox"/>19.0"</td> <td><input type="checkbox"/>19.5"</td> </tr> </tbody> </table>	Your Rear Tire Size	Rear Seat Height								24"x1"(540)	<input type="checkbox"/> 16.0"	<input type="checkbox"/> 16.5"	<input type="checkbox"/> 17.0"	<input type="checkbox"/> 17.5"	<input type="checkbox"/> 18.0"	<input type="checkbox"/> 18.5"			24"x1.2"(540)		<input type="checkbox"/> 16.5"	<input type="checkbox"/> 17.0"	<input type="checkbox"/> 17.5"	<input type="checkbox"/> 18.0"	<input type="checkbox"/> 18.5"	<input type="checkbox"/> 19.0"		24"x1 3/8"(540)		<input type="checkbox"/> 16.5"	<input type="checkbox"/> 17.0"	<input type="checkbox"/> 17.5"	<input type="checkbox"/> 18.0"	<input type="checkbox"/> 18.5"	<input type="checkbox"/> 19.0"		25"x1"(559)		<input type="checkbox"/> 16.5"	<input type="checkbox"/> 17.0"	<input type="checkbox"/> 17.5"	<input type="checkbox"/> 18.0"	<input type="checkbox"/> 18.5"	<input type="checkbox"/> 19.0"		25"x1.2"(559)			<input type="checkbox"/> 17.0"	<input type="checkbox"/> 17.5"	<input type="checkbox"/> 18.0"	<input type="checkbox"/> 18.5"	<input type="checkbox"/> 19.0"		24"x2"(540)			<input type="checkbox"/> 17.0"	<input type="checkbox"/> 17.5"	<input type="checkbox"/> 18.0"	<input type="checkbox"/> 18.5"	<input type="checkbox"/> 19.0"		26"x1"(590)			<input type="checkbox"/> 17.0"	<input type="checkbox"/> 17.5"	<input type="checkbox"/> 18.0"	<input type="checkbox"/> 18.5"	<input type="checkbox"/> 19.0"		25"x1.95"(559)				<input type="checkbox"/> 17.5"	<input type="checkbox"/> 18.0"	<input type="checkbox"/> 18.5"	<input type="checkbox"/> 19.0"	<input type="checkbox"/> 19.5"	
Your Rear Tire Size	Rear Seat Height																																																																																		
24"x1"(540)	<input type="checkbox"/> 16.0"	<input type="checkbox"/> 16.5"	<input type="checkbox"/> 17.0"	<input type="checkbox"/> 17.5"	<input type="checkbox"/> 18.0"	<input type="checkbox"/> 18.5"																																																																													
24"x1.2"(540)		<input type="checkbox"/> 16.5"	<input type="checkbox"/> 17.0"	<input type="checkbox"/> 17.5"	<input type="checkbox"/> 18.0"	<input type="checkbox"/> 18.5"	<input type="checkbox"/> 19.0"																																																																												
24"x1 3/8"(540)		<input type="checkbox"/> 16.5"	<input type="checkbox"/> 17.0"	<input type="checkbox"/> 17.5"	<input type="checkbox"/> 18.0"	<input type="checkbox"/> 18.5"	<input type="checkbox"/> 19.0"																																																																												
25"x1"(559)		<input type="checkbox"/> 16.5"	<input type="checkbox"/> 17.0"	<input type="checkbox"/> 17.5"	<input type="checkbox"/> 18.0"	<input type="checkbox"/> 18.5"	<input type="checkbox"/> 19.0"																																																																												
25"x1.2"(559)			<input type="checkbox"/> 17.0"	<input type="checkbox"/> 17.5"	<input type="checkbox"/> 18.0"	<input type="checkbox"/> 18.5"	<input type="checkbox"/> 19.0"																																																																												
24"x2"(540)			<input type="checkbox"/> 17.0"	<input type="checkbox"/> 17.5"	<input type="checkbox"/> 18.0"	<input type="checkbox"/> 18.5"	<input type="checkbox"/> 19.0"																																																																												
26"x1"(590)			<input type="checkbox"/> 17.0"	<input type="checkbox"/> 17.5"	<input type="checkbox"/> 18.0"	<input type="checkbox"/> 18.5"	<input type="checkbox"/> 19.0"																																																																												
25"x1.95"(559)				<input type="checkbox"/> 17.5"	<input type="checkbox"/> 18.0"	<input type="checkbox"/> 18.5"	<input type="checkbox"/> 19.0"	<input type="checkbox"/> 19.5"																																																																											
<b>9. CENTER OF GRAVITY</b>	<input type="checkbox"/> 3.5" <input type="checkbox"/> 4.0" <input type="checkbox"/> 4.5" <input type="checkbox"/> 5.0" <input type="checkbox"/> 5.5" <input type="checkbox"/> 6.0" <input type="checkbox"/> 6.5" <input type="checkbox"/> 7.0" .....	\$ STD																																																																																	
<b>10. CAMBER ANGLE</b>	<input type="checkbox"/> 0° <input type="checkbox"/> 2° <input type="checkbox"/> 4° .....	\$ STD																																																																																	
<b>11. FROM GROUND TO TOP OF FOOTREST</b>  OR <b>FROM SEAT SLING TO TOP OF FOOTREST</b>	 <p style="text-align:center;">* Only Choose One Measurement</p>	\$ STD																																																																																	
<b>12. INSIDE WHEEL CLEARANCE</b>	<input type="checkbox"/> 3/4" <input type="checkbox"/> 1" <input type="checkbox"/> 1 1/4" <input type="checkbox"/> 1 1/2" <input type="checkbox"/> 1 3/4" <input type="checkbox"/> 2" *3/4" Inside wheel clearance not available with D's Locks	\$ STD																																																																																	
<b>13. REAR SUSPENSION RATING</b>	<input type="checkbox"/> Set up 50psi (For 80 lbs-110 lbs weight) <input type="checkbox"/> Set up 100psi (For 170 lbs-200 lbs weight) <input type="checkbox"/> Set up 60psi (For 110 lbs-140 lbs weight) <input type="checkbox"/> Set up 120psi (For 200 lbs-230 lbs weight) <input type="checkbox"/> Set up 80psi (For 140 lbs-170 lbs weight) <input type="checkbox"/> Set up 150psi (For 230 lbs-250 lbs weight)	\$ STD																																																																																	
<b>* Air Pro Kit Included</b>	<b>Pick Air Tube Color</b> <input type="checkbox"/> Black																																																																																		
<b>*SHOCK PUMP</b>	<input type="checkbox"/> Fox Racing Shox 300 HP Pump <input type="checkbox"/> Omit Pump *Customer Needs Pump To Adjust Rear Suspension Rating	\$ STD \$ -50																																																																																	
<b>NOTE</b>																																																																																			

**D COMPONENTS**

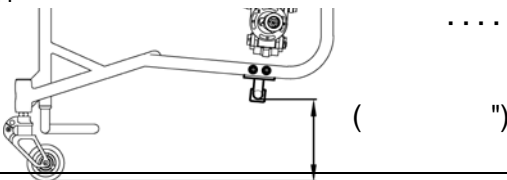
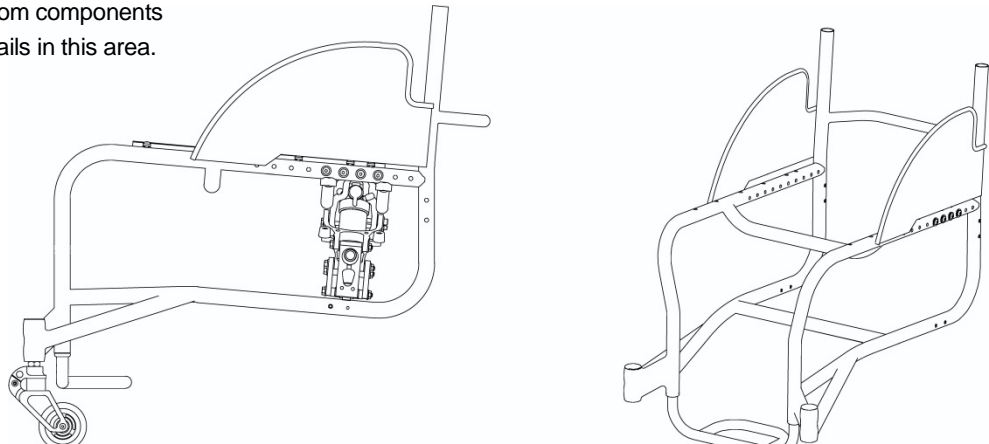
<b>WHEEL LOCKS</b>		\$ STD
<input type="checkbox"/> Gallop Push To Lock w/ 1" Clamp		\$ STD
<input type="checkbox"/> Question Mark Style Scissor		\$ STD
<input type="checkbox"/> NEW <b>Compact Scissor Lock</b> / Anodized Black		\$ 146
<input type="checkbox"/> <b>Gallop Scissor Lock</b> / Anodized		\$ 146
<b>PUSH HANDLES</b>		
<input type="checkbox"/> <b>Integrated</b> w/Fixed Backrest Height / Anodized Black Only		\$ STD
<input type="checkbox"/> <b>Bolt-on</b> / Anodized Black Only Specify Height from floor -( )		\$ 188
<input type="checkbox"/> <b>Bolt-on w/Quick Release</b> / Anodized Black Only Specify Height from floor -( )		\$ 252
<input type="checkbox"/> NEW <b>Height Adj.</b> / Anodized Black Only Specify Maximum height from floor -( )		\$ 390
<b>ANTI-TIPPERS</b>		
<input type="checkbox"/> <b>Press Release Removable Anti-tipper</b>		\$ 330
<b>ACCESSORIES</b>		
<input type="checkbox"/> <b>Frame Protectors</b> / Black Leather/Zipper Type		\$ 108
<input type="checkbox"/> <b>Gel Ovation Protector Wraps</b> Gel Silicone <input type="checkbox"/> Short (1/2") <input type="checkbox"/> Long (3")		\$ 132
<input type="checkbox"/> <b>Padded Seat Belt</b> w/Auto Buckle Black Belt Only		\$ 113
<input type="checkbox"/> <b>Calf Strap</b> <input type="checkbox"/> Black <input type="checkbox"/> Matching Fabric ( <b>\$55 up charge</b> ) -Select Fabric( )		\$ 35
<input type="checkbox"/> <b>Bodypoint Padded Calf Strap</b> <input type="checkbox"/> (14"-16" footrest width) <input type="checkbox"/> (16"-20" footrest width) <input type="checkbox"/> (20"-24") ft \$89 \$95 \$102		
<input type="checkbox"/> <b>SEAT FOAM CUSHION</b> w/Nylon Black Cover		\$ CFP
Thickness <input type="checkbox"/> 1" <input type="checkbox"/> 2" <input type="checkbox"/> 3" <input type="checkbox"/> 4"		
<input type="checkbox"/> <b>Hanging Zipper Pouch</b> <input type="checkbox"/> Black <input type="checkbox"/> Matching Fabric ( <b>\$75</b> ) <input type="checkbox"/> Leather ( <b>\$80</b> )		\$ 86
Custom Size: Width: Length:		
<input type="checkbox"/> <b>Ratchet Strap</b> <input type="checkbox"/> <b>Small</b> <input type="checkbox"/> <b>Medium</b> <input type="checkbox"/> <b>Large</b> <b>Where on chair:</b> _____ 8" Pads 10" Pads 12" Pads <b>ex: footplate, hips, knees, front legs.</b>		
\$ 288 \$ 288 \$ 311		
<input type="checkbox"/> <b>Grind Bar</b> <b>► Must Specify Measurement</b>		\$ 200
		
<b>UPHOLSTERY STYLE, COLOR &amp; FABRIC</b>		<b>*Positioning Back Available. Please see Section E</b>
<b>STYLE</b>		
<input type="checkbox"/> <b>Standard Adjustable Height Backrest</b> Black		\$ STD
<input type="checkbox"/> <b>Adjustable Tension Backrest</b> Black Only (*Not available with 8" Backrest Height)		\$ 173
Custom Options	<input type="checkbox"/> Fun Fabric: For Std. or Adj. Style (Choose From Choices on Page 7 and write choice below) ( <b>\$92 up</b> )	
	<input type="checkbox"/> <b>Backrest Leather Trim</b> (outside panels)	<b>(\$up charge)DEPENDS ON MEASUREMENTS</b>
If you want additional custom components Please write down the details in this area.		
		\$ CFP

FABRIC CHOICE SHEET

1. Camouflage Girls

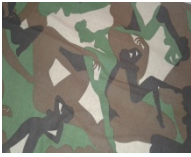

2. Purple Zebra



3. Silver Grey Snake



5. Laughing Skulls



6. Purple Snake



7. Sweetheart Pinup Girls



9. Blue Flames

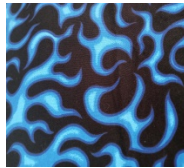

10. Arctic Camo



11. Furry Friends



12. Supercars



13. Urban Camo

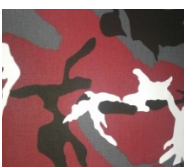

14. Superbikes



15. Sizzle Flames



16. Hot Rod Flames



17. Skulls w/ Attitude



18. Sweet Pink

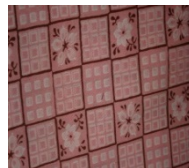

19. Heart and Soul



20. Home Run



21. Fuzzy Giraffe

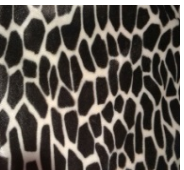

22. Cheetah



23. Paperweight Cobalt



24. Zig Zag Dots



25. Smokey Tribal Flames

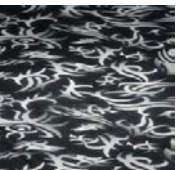

26. Rose and Rebellion



27. Tattoo Adventure(Cream

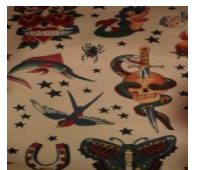

28. Red Tribal Flames

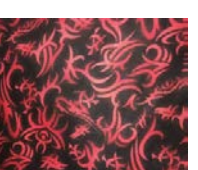

29. Tattoo Adventure(Black)

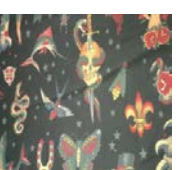

30. Butterfly Bandana

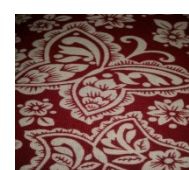

31. Tatsu Dragon

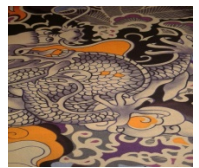

**E TIRES, CASTERS, & FORKS**

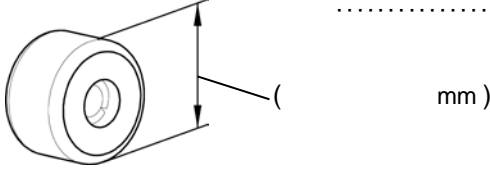

TIRES			
<input type="checkbox"/> <b>Primo V-Trak High Pressure Tire</b> <input type="checkbox"/> 24"x1" <input type="checkbox"/> 25"x1" or <input type="checkbox"/> 26"x1"	Gray Tire with black wall Only	.....	\$ STD
<input type="checkbox"/> <b>Primo High Pressure Tire</b> <input type="checkbox"/> 24"x1" <input type="checkbox"/> 25"x1" or <input type="checkbox"/> 26"x1"	<input type="checkbox"/> Blue <input type="checkbox"/> Red	.....	\$ 100
<input type="checkbox"/> <b>Schwalbe Air Born Tire</b> <input type="checkbox"/> 24"x1.2"(540) <input type="checkbox"/> 25"x1.2"(559)		.....	\$ NCO
<input type="checkbox"/> <b>Schwalbe Marathon Plus High Pressure Tire</b> <input type="checkbox"/> 24"x1" <input type="checkbox"/> 25"x1" or <input type="checkbox"/> 26"x1"	Black Only	.....	\$ NCO
<input type="checkbox"/> <b>Solid Tire</b> <input type="checkbox"/> 24"x1" <input type="checkbox"/> 25"x1" Black <input type="checkbox"/> 26"x1"		.....	\$ 219
<input type="checkbox"/> <b>Kobra Knobby Tire</b> 24"x 2" (50-540) (Street Tire. Off Road Conditions: gravel, grass, & dirt))	Gray Only <input type="checkbox"/> Blue Line <input type="checkbox"/> Red Line		\$ 155
<input type="checkbox"/> <b>Kobra Knobby Tire</b> 26"x 2" (50-559) (Street Tire. Off Road Conditions: gravel, grass, & dirt))	Gray Only <input type="checkbox"/> Blue Line <input type="checkbox"/> Red Line		\$ 155
<input type="checkbox"/> <b>Nevegal Knobby Tire</b> (540) 24"x 1.95" 559(50-559)	Black Only (off road example: traction, snow, mud, & sand)		\$ 155
<input type="checkbox"/> <b>Kenda Knobby Tire(Kwick Drumlin)</b> 559(50-559)	(559) 26" X 1.75 - 2.25 Black Only (wet or loose conditions, concrete, gravel paths and forest roads. Designed to prevent punctures)		\$ 155

CASTERS					
<input type="checkbox"/> <b>Customer to Supply Skate Wheels</b>		.....	\$ STD		
▶ Please give us the wheel diameter					
SIZE	TIRE WIDTH	HUB COLOR	TIRE COLOR	DESCRIPTION	
<input type="checkbox"/> 3"	1"	Black Hub	Black Tire Only	Polyurethane	\$ NCO
<input type="checkbox"/> 3"	1"	Plastic Black Hub	Clear Tire Only	Lighted, Polyurethane	\$ 86
<input type="checkbox"/> 3"	1"	Black Hub	Red Tire Only	Polyurethane	\$ NCO
<input type="checkbox"/> 3"	1"	Black Hub	Clear Tire Only	Polyurethane	\$ NCO
<input type="checkbox"/> 3"	1"	Aluminum Silver Hub	Black Tire Only	Soft Roll Made By Frog Legs	\$ 209
<input type="checkbox"/> 3"	1"	Aluminum Black Hub	Black Tire Only	Soft Roll Made By Frog Legs	\$ 209
<input type="checkbox"/> 3"	1.5"	Aluminum Silver Hub	Black Tire Only	Soft Roll Made By Frog Legs	\$ 209
<input type="checkbox"/> 3"	1.5"	Aluminum Black Hub	Black Tire Only	Soft Roll Made By Frog Legs	\$ 209
<input type="checkbox"/> 3"	<input type="checkbox"/> 1" or <input type="checkbox"/> 1.5"	Hub Color:	Tread Color:	Soft Roll Made By Frog Legs	\$ CFP

FORKS			
<b>Pro Sport Frog Leg</b> Suspension Forks Only			
<input type="checkbox"/> <b>Frog Leg</b> Suspension Forks <b>Std 1" Wide</b> (For 3", 4" x 1" width Caster and 5" STD Caster, 5" lighted Caster) Not for 4 x 1 1/8 STD	Color <input type="checkbox"/> Anodized Black	.....	\$ NCO
▶ End User Weight Required: _____ lbs			
<input type="checkbox"/> <b>Frog Leg</b> Suspension Forks <b>1.5" Wide</b> (For 3", 4" x 1.5" width Caster and 5" x 1"& 5" x 1.5" Casters )	Color <input type="checkbox"/> Anodized Black	.....	\$ NCO
▶ End User Weight Required: _____ lbs			
<input type="checkbox"/> <b>Frog Leg Shields(4pcs)</b>			\$ 30



**F WHEELS**

WHEELS																				
<b>Wire Wheels</b>		<input type="checkbox"/> 24" (540) <input type="checkbox"/> 25" (559) <input type="checkbox"/> 26" (590)	\$ NCO \$ NCO																	
<b>Spinergy Sport Lite Extreme "SLX" 24 Spoke</b> 	<input type="checkbox"/> 24" (540) <input type="checkbox"/> 25" (559) <input type="checkbox"/> 26" (590)	Spoke Color <input type="checkbox"/> Black With Silver Hub <input type="checkbox"/> White With Black Hub <input type="checkbox"/> Purple With Black Hub <input type="checkbox"/> Red With Black Hub <input type="checkbox"/> Neon Green With Black Hub <input type="checkbox"/> Yellow With Black Hub <input type="checkbox"/> Pink With Black Hub <input type="checkbox"/> Blue With Black Hub <input type="checkbox"/> Orange With Black Hub	\$ 1,166 ..... ..... (+\$110)																	
	<input type="checkbox"/> Custom Color Spoke Pattern			<table border="1"> <thead> <tr> <th colspan="2"></th> <th>Left Wheel</th> <th>Right Wheel</th> </tr> </thead> <tbody> <tr> <td>Spokes</td> <td>Inside</td> <td></td> <td></td> </tr> <tr> <td>Color</td> <td>Outside</td> <td></td> <td></td> </tr> <tr> <td colspan="2">Hub Color</td> <td><input type="checkbox"/> Black/<input type="checkbox"/> Silver</td> <td><input type="checkbox"/> Black/<input type="checkbox"/> Silver</td> </tr> </tbody> </table>			Left Wheel	Right Wheel	Spokes	Inside			Color	Outside			Hub Color		<input type="checkbox"/> Black/ <input type="checkbox"/> Silver	<input type="checkbox"/> Black/ <input type="checkbox"/> Silver
				Left Wheel	Right Wheel															
	Spokes	Inside																		
Color	Outside																			
Hub Color		<input type="checkbox"/> Black/ <input type="checkbox"/> Silver	<input type="checkbox"/> Black/ <input type="checkbox"/> Silver																	
<b>Spinergy X-Laced Sport Lite Extreme "XSLX" 24 spoke</b> 	<input type="checkbox"/> 24" (540) <input type="checkbox"/> 25" (559) <input type="checkbox"/> 26" (590)	<input type="checkbox"/> Black With Silver Hub <input type="checkbox"/> White With Black Hub <input type="checkbox"/> Purple With Black Hub <input type="checkbox"/> Red With Black Hub <input type="checkbox"/> Neon Green With Black Hub <input type="checkbox"/> Yellow With Black Hub <input type="checkbox"/> Pink With Black Hub <input type="checkbox"/> Blue With Black Hub <input type="checkbox"/> Orange With Black Hub	\$ 1,210 ..... ..... (+\$110)																	
	<input type="checkbox"/> Custom Color Spoke Pattern			<table border="1"> <thead> <tr> <th colspan="2"></th> <th>Left Wheel</th> <th>Right Wheel</th> </tr> </thead> <tbody> <tr> <td>Spokes</td> <td>Inside</td> <td></td> <td></td> </tr> <tr> <td>Color</td> <td>Outside</td> <td></td> <td></td> </tr> <tr> <td colspan="2">Hub Color</td> <td><input type="checkbox"/> Black/<input type="checkbox"/> Silver</td> <td><input type="checkbox"/> Black/<input type="checkbox"/> Silver</td> </tr> </tbody> </table>			Left Wheel	Right Wheel	Spokes	Inside			Color	Outside			Hub Color		<input type="checkbox"/> Black/ <input type="checkbox"/> Silver	<input type="checkbox"/> Black/ <input type="checkbox"/> Silver
				Left Wheel	Right Wheel															
	Spokes	Inside																		
Color	Outside																			
Hub Color		<input type="checkbox"/> Black/ <input type="checkbox"/> Silver	<input type="checkbox"/> Black/ <input type="checkbox"/> Silver																	
HANDRIMS																				
<b>Type</b>	<input type="checkbox"/> <b>Standard</b> For 24", 25" or 26" Wheel Anodized Black .....		\$ STD																	
	<input type="checkbox"/> <b>Vinyl Coated</b> For 24", 25", 26" Wheel Not available with Y-360 Billet Wheels .....		\$ 200																	
	<input type="checkbox"/> <b>Spinergy Silver Brushed Anodized</b> For 24", 25" & 26" Wheels Not available with Y-360 Billet Wheels .....		\$ 176																	
	<input type="checkbox"/> <b>Natural Fit</b> For 24", 25" & 26" Wheel																			
	<input type="checkbox"/> Standard Grip (Not available with short tabs. Not available with Y-360 Billet Wheels .....		\$ 570																	
	<input type="checkbox"/> Super Grip (Not available with short tabs. Not available with Y-360 Billet Wheels .....		\$ 645																	
	<input type="checkbox"/> Without Thumb Grip ( Not available with Y-360 Billet Wheels .....		\$ 338																	
	<input type="checkbox"/> <b>Natural Fit (LT)</b> For 24", 25" & 26" Wheel																			
	<input type="checkbox"/> Standard Grip (Not available with short tabs. Not available with Y-360 Billet Wheels .....		\$ 629																	
	<input type="checkbox"/> Super Grip (Not available with short tabs. Not available with Y-360 Billet Wheels .....		\$ 706																	
<input type="checkbox"/> Without Thumb Grip ( Not available with Y-360 Billet Wheels .....		\$ 400																		
<input type="checkbox"/> <b>The Surge Handrims</b> * Not available with Y-360 Billet Wheels .....		\$ 553																		
<input type="checkbox"/> <b>The Surge Handrims (LT)</b> * Not available with Y-360 Billet Wheels .....		\$ 603																		
<input type="checkbox"/> <b>The Q-Grip Handrims</b> : anti-slip, latex-free, neoprene coating * Not available with Y-360 Billet Wheels		\$ 543																		
<input type="checkbox"/> <b>OMIT HANDRIMS</b>		\$ NCO																		
<b>TAB LENGTH</b>	<input type="checkbox"/> Long Tab ( <b>STD</b> inside clearance 3/4") * Not available with Y-360 Wheels.		\$ STD																	
	<input type="checkbox"/> Short Tab (Inside clearance 1/2") *Not available with Natural Fit Handrim with thumb grip .....		\$ STD																	
	<input type="checkbox"/> Short Tab (Set closest to wheel cut off excess) .....		\$ 35																	
<b>NOTES</b>																				

**G CHAIR OPTIONS 1 / 3**

SEAT CUSHION									
<b>SUPRACOR® WHEELCHAIR CUSHIONS</b>									
<b>Stimulite® Contoured Cushion</b> *Black Upholstery only  *Comes with Zipper Pouch <input type="checkbox"/> Extra Sensitive (\$35 up charge) <input type="checkbox"/> Sling Style Bottom (\$52 up charge) <input type="checkbox"/> Custom Size (\$- CFP) W(    " ) x D(    " ) <input type="checkbox"/> Extra Cover (\$120 up charge)	<input type="checkbox"/> W14"xD16" (CD1416)	.....						<b>E2603</b>	\$ 707
	<input type="checkbox"/> W16"xD16" (CD1616)	.....						<b>E2603</b>	\$ 707
	<input type="checkbox"/> W16"xD18" (CD1618)	.....						<b>E2603</b>	\$ 707
	<input type="checkbox"/> W18"xD16" (CD1816)	.....						<b>E2603</b>	\$ 707
	<input type="checkbox"/> W18"xD18" (CD1818)	.....						<b>E2603</b>	\$ 707
	<input type="checkbox"/> W18"xD20" (CD1820)	.....						<b>E2603</b>	\$ 714
	<input type="checkbox"/> W20"xD16" (CD2016)	.....						<b>E2603</b>	\$ 714
	<input type="checkbox"/> W20"xD18" (CD2018)	.....						<b>E2603</b>	\$ 714
	<input type="checkbox"/> W20"xD20" (CD2020)	.....						<b>E2603</b>	\$ 734
	<b>Stimulite® Slimline Cushion</b> *Black Upholstery only  <input type="checkbox"/> Extra Sensitive (\$35 up charge) <input type="checkbox"/> Sling Style Bottom (\$52 up charge) <input type="checkbox"/> Custom Size (\$- CFP) W(    " ) x D(    " ) <input type="checkbox"/> Extra Cover (\$86 up charge)	<input type="checkbox"/> W14"xD16" (SM1416)	.....						<b>E2603</b>
<input type="checkbox"/> W16"xD16" (SM1616)		.....						<b>E2603</b>	\$ 446
<input type="checkbox"/> W16"xD18" (SM1618)		.....						<b>E2603</b>	\$ 446
<input type="checkbox"/> W18"xD18" (SM1818)		.....						<b>E2603</b>	\$ 446
<input type="checkbox"/> W18"xD20" (SM1820)		.....						<b>E2603</b>	\$ 490
<input type="checkbox"/> W20"xD16" (SM2016)		.....						<b>E2603</b>	\$ 490
<input type="checkbox"/> W20"xD18" (SM2018)		.....						<b>E2603</b>	\$ 490
<input type="checkbox"/> W20"xD20" (SM2020)		.....						<b>E2603</b>	\$ 518
<b>Stimulite® Corbee Pediatric</b> *Black Upholstery only <input type="checkbox"/> Extra Cover (\$86 up charge)	<input type="checkbox"/> W10"xD10" (PD1010)	.....						<b>E2603</b>	\$ 342
	<input type="checkbox"/> W12"xD12" (PD1212)	.....						<b>E2603</b>	\$ 342
	<input type="checkbox"/> W14"xD14" (PD1414)	.....						<b>E2603</b>	\$ 342
									<input type="checkbox"/> Extra Sensitive (\$35 up charge) <input type="checkbox"/> Sling Style Bottom (\$52 up charge) <input type="checkbox"/> Custom Size W(    " ) x D(    " ) (\$- CFP)
<b>ROHO WHEELCHAIR CUSHIONS</b>									
Choose Size	<input type="checkbox"/> <b>4" HIGH PROFILE® QUADTRO SELECT® CUSHION</b> *Black Upholstery ..... <input type="checkbox"/> Extra Cover (\$+100) ..... only- <b>E2622-2623</b>								\$ 669
	<input type="checkbox"/> W12"xD12"	<input type="checkbox"/> W12"xD13"	<input type="checkbox"/> W13"xD13"	<input type="checkbox"/> W13"xD15"	<input type="checkbox"/> W13"xD16"	<input type="checkbox"/> W15"xD13"	<input type="checkbox"/> W15"xD15"		
	<input type="checkbox"/> W15"xD16"	<input type="checkbox"/> W15"xD18"	<input type="checkbox"/> W16"xD15"	<input type="checkbox"/> W16"xD16"	<input type="checkbox"/> W16"xD18"	<input type="checkbox"/> W16"xD20"	<input type="checkbox"/> W18"xD15"		
	<input type="checkbox"/> W18"xD16"	<input type="checkbox"/> W18"xD18"	<input type="checkbox"/> W18"xD20"	<input type="checkbox"/> W18"xD22"	<input type="checkbox"/> W20"xD16"	<input type="checkbox"/> W20"xD18"	<input type="checkbox"/> W20"xD20"		
	<input type="checkbox"/> W20"xD22"	<input type="checkbox"/> W22"xD18"	<input type="checkbox"/> W22"xD20"	<input type="checkbox"/> W22"xD22"	<input type="checkbox"/> Custom Size W(    " ) x D(    " ) (\$+CFP)				
Choose Size	<input type="checkbox"/> <b>3" MID PROFILE® QUADTRO SELECT® CUSHION</b> *Black Upholstery only ..... <input type="checkbox"/> Extra Cover (\$+100) ..... <b>E2622-2623</b>								\$ 669
	<input type="checkbox"/> W15"xD15"	<input type="checkbox"/> W15"xD16"	<input type="checkbox"/> W16"xD16"	<input type="checkbox"/> W16"xD18"	<input type="checkbox"/> W18"xD16"	<input type="checkbox"/> W18"xD18"			
	<input type="checkbox"/> Custom Size W(    " ) x D(    " ) (\$+CFP)								
Choose Size	<input type="checkbox"/> <b>2" LOW PROFILE® QUADTRO SELECT® CUSHION</b> *Black Upholstery only ..... <input type="checkbox"/> Extra Cover (\$+100) ..... <b>E2622-2623</b>								\$ 669
	<input type="checkbox"/> W12"xD12"	<input type="checkbox"/> W12"xD13"	<input type="checkbox"/> W13"xD13"	<input type="checkbox"/> W13"xD15"	<input type="checkbox"/> W13"xD16"	<input type="checkbox"/> W15"xD13"	<input type="checkbox"/> W15"xD15"		
	<input type="checkbox"/> W15"xD16"	<input type="checkbox"/> W15"xD18"	<input type="checkbox"/> W16"xD15"	<input type="checkbox"/> W16"xD16"	<input type="checkbox"/> W16"xD18"	<input type="checkbox"/> W16"xD20"	<input type="checkbox"/> W18"xD15"		
	<input type="checkbox"/> W18"xD16"	<input type="checkbox"/> W18"xD18"	<input type="checkbox"/> W18"xD20"	<input type="checkbox"/> W20"xD16"	<input type="checkbox"/> W20"xD18"	<input type="checkbox"/> W20"xD20"			
	<input type="checkbox"/> Custom Size W(    " ) x D(    " ) (\$+CFP)								
<b>THE CURVE CUSHION</b> *Black Upholstery only <input type="checkbox"/> Extra Cover(\$+ 46)	<input type="checkbox"/> W10"xD10"	<input type="checkbox"/> W10"xD11"	<input type="checkbox"/> W10"xD11"	<input type="checkbox"/> W10"xD12"	<input type="checkbox"/> W11"xD12"	<input type="checkbox"/> W12"xD12"			\$ 146
	<input type="checkbox"/> W12"xD13"	<input type="checkbox"/> W12"xD14"	<input type="checkbox"/> W13"xD11"	<input type="checkbox"/> W13"xD12"	<input type="checkbox"/> W13"xD13"	<input type="checkbox"/> W13"xD14"			
	<input type="checkbox"/> W14"xD14"	<input type="checkbox"/> W14"xD15"	<input type="checkbox"/> W14"xD16"	<input type="checkbox"/> W15"xD14"	<input type="checkbox"/> W15"xD15"	<input type="checkbox"/> W15"xD16"			
	<input type="checkbox"/> W16"xD14"	<input type="checkbox"/> W16"xD15"	<input type="checkbox"/> W16"xD16"	<input type="checkbox"/> W16"xD17"	<input type="checkbox"/> W16"xD18"	<input type="checkbox"/> W17"xD16"			
	<input type="checkbox"/> W17"xD17"	<input type="checkbox"/> W17"xD18"	<input type="checkbox"/> W18"xD16"	<input type="checkbox"/> W18"xD17"	<input type="checkbox"/> W18"xD18"				

**G CHAIR OPTIONS 2 / 3**

SEAT CUSHION				
<b>Exgel Kaji Cushion</b>				
<b>For Comfortable Sitting To Prevent Pressure Sores</b>				
<input type="checkbox"/> <b>Owl Regular(1.6" Thick)</b> Incontinence Cover Only	<input type="checkbox"/> W14"xD16" <input type="checkbox"/> W15"xD16" <input type="checkbox"/> W16"xD16" <input type="checkbox"/> W18"xD16"	..... ..... ..... ..... * No Custom Sizes	<input type="checkbox"/> <b>Extra Cover \$104</b>	E2603 \$ 362 E2603 \$ 362 E2603 \$ 362 E2603 \$ 408
<input type="checkbox"/> <b>Owl High(3.1" Thick)</b> Incontinence Cover Only	<input type="checkbox"/> W14"xD16" <input type="checkbox"/> W15"xD16" <input type="checkbox"/> W16"xD16" <input type="checkbox"/> W18"xD16" <input type="checkbox"/> W18"xD18"	..... ..... ..... ..... ..... * No Custom Sizes	<input type="checkbox"/> <b>Extra Cover \$104</b>	E2603 \$ 437 E2603 \$ 437 E2603 \$ 437 E2603 \$ 495 E2603 \$ 495
<input type="checkbox"/> <b>Owl Contour(3.0" Thick)</b> Incontinence Cover Only	<input type="checkbox"/> W14"xD16" <input type="checkbox"/> W15"xD16" <input type="checkbox"/> W16"xD16" <input type="checkbox"/> W18"xD16"	..... ..... ..... .....	<input type="checkbox"/> <b>Extra Cover \$104</b>	E2603 \$ 454 E2603 \$ 454 E2603 \$ 454 E2603 \$ 495
<input type="checkbox"/> <b>Owl Deep Contour(4.3" Thick)</b>		* No Custom Sizes- Incontinence Cover Only		
<input type="checkbox"/> W14"xD16" \$518 <input type="checkbox"/> W15"xD16" \$518 <input type="checkbox"/> W16"xD16" \$518 <input type="checkbox"/> W18"xD16" \$558		<input type="checkbox"/> <b>Extra Cover \$104</b>		
<input type="checkbox"/> <b>Standard Regular(1.4" Thick)</b> Easy to Use Flat Style (superior pressure redistribution)		<b>For Pressure</b>		E2622-2623
<input type="checkbox"/> W12" x D12" \$368 <input type="checkbox"/> W13" x D13" \$368 <input type="checkbox"/> W14" x D14" \$368 <input type="checkbox"/> W14" x D16" \$368 <input type="checkbox"/> W16" x D16" \$368	<input type="checkbox"/> W16" x D17" \$368 <input type="checkbox"/> W17" x D16" \$368 <input type="checkbox"/> W17" x D17" \$368 <input type="checkbox"/> W18" x D16" \$391 <input type="checkbox"/> W18" x D18" \$391	<input type="checkbox"/> <b>Extra Cover \$104</b> * No Custom Sizes- Incontinence Cover Only		
<input type="checkbox"/> W18" x D19" \$440 <input type="checkbox"/> W18" x D20" \$440 <input type="checkbox"/> W19" x D19" \$440				
<input type="checkbox"/> <b>Standard High(2.6" Thick)</b> Incontinence Cover Only		.....		E2622
*Black Upholstery only				
<input type="checkbox"/> W12" x D12" \$383 <input type="checkbox"/> W13" x D13" \$ 383 <input type="checkbox"/> W14" x D14" \$383 <input type="checkbox"/> W14" x D16" \$ 383 <input type="checkbox"/> W16" x D16" \$383	<input type="checkbox"/> W16" x D17" \$383 <input type="checkbox"/> W17" x D16" \$383 <input type="checkbox"/> W17" x D17" \$383 <input type="checkbox"/> W18" x D16" \$460 <input type="checkbox"/> W18" x D18" \$460	<input type="checkbox"/> W18" x D19" \$512 <input type="checkbox"/> W18" x D20" \$512 <input type="checkbox"/> W19" x D19" \$512 <input type="checkbox"/> W18" x D19" \$512		
<input type="checkbox"/> <b>Extra Cover \$104</b>				
<input type="checkbox"/> <b>Standard Anti-Thrust(2.6" Thick)</b> * No Custom Sizes Incontinence Cover Only	<input type="checkbox"/> W16 x D16 \$460 <input type="checkbox"/> W18 x D16 \$500 <input type="checkbox"/> W18 x D18 \$500	Prevents Unwanted Forward Movement of lower back and hip bone	<input type="checkbox"/> <b>Extra Cover \$104</b>	
<input type="checkbox"/> <b>Lite Regular(2.2" Thick)</b>	<input type="checkbox"/> W16" x D16" \$374 <input type="checkbox"/> W18" x D16" \$397 <input type="checkbox"/> W18" x D18" \$397	* No Custom Sizes- Incontinence Cover Only		
<input type="checkbox"/> <b>Extra Cover \$104</b>				
<input type="checkbox"/> <b>Lite High(3.0" Thick)</b>	<input type="checkbox"/> W16" x D16" \$408 <input type="checkbox"/> W18" x D16" \$431 <input type="checkbox"/> W18" x D18" \$431	* No Custom Sizes- Incontinence Cover Only		
<input type="checkbox"/> <b>Extra Cover \$104</b>				

**H CHAIR OPTIONS 3 / 3**

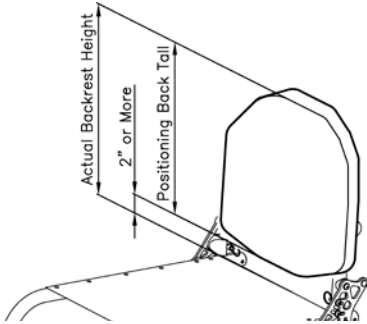
<b>POSITIONING BACK</b>					
<p><b>*Note : Actual height of the backrest will increase 2" or more.</b></p> 					
<b>ADI CARBON BACKREST (Support Contour-ACTIVE 2.5")</b>					
Mounting Hardware: <input type="checkbox"/> 2 Point Pro <input type="checkbox"/> Quick Release					
Height	<input type="checkbox"/> LOW (10" Tall) *Backrest Height requires 12" or more *Available 13"-19" width	Width ( " )	<b>E2613</b>	\$	986
	<input type="checkbox"/> Medium (13" Tall) *Backrest Height requires 15" or more *Available 13"-19" width	Width ( " )	<b>E2613</b>	\$	1,078
<input type="checkbox"/> Add Privacy Flap	<input type="checkbox"/> Standard (16" Tall) *Backrest Height requires 18" or more *Available 13"-19" width	Width ( " )	<b>E2613</b>	\$	1,164
<b>(\$80 up charge)</b>	<input type="checkbox"/> Custom Size ( " Tall) x ( " width) . . . . .		<b>E2613</b>	\$	CFP
<b>ADI ALUMINUM BACKREST (Support Contour-ACTIVE 2.5")</b>					
Mounting Hardware: <input type="checkbox"/> 2 Point Pro <input type="checkbox"/> Quick Release					
Height	<input type="checkbox"/> LOW (10" Tall) *Backrest Height requires 12" or more *Available 10"-20" width	Width ( " )	<b>E2613</b>	\$	807
	<input type="checkbox"/> Medium (13" Tall) *Backrest Height requires 15" or more *Available 12"-20" width	Width ( " )	<b>E2613</b>	\$	827
	<input type="checkbox"/> Standard (16" Tall) *Backrest Height requires 18" or more *Available 14"-20" width	Width ( " )	<b>E2613</b>	\$	846
	<input type="checkbox"/> Tall (18" Tall) *Backrest Height requires 20" or more *Available 16"-20" width	Width ( " )	<b>E2613</b>	\$	866
<input type="checkbox"/> Add Privacy Flap	<input type="checkbox"/> X-Tall (20" Tall) *Backrest Height requires 22" or more *Available 16"-20" width	Width ( " )	<b>E2613</b>	\$	886
<b>(\$80 up charge)</b>	<input type="checkbox"/> Custom Size ( " Tall) x ( " width) . . . . .		<b>E2613</b>	\$	CFP
<b>ADI ALUMINUM BACKREST (Support Contour-DEEP 4") *Not Available with Lateral Supports</b>					
Mounting Hardware: <input type="checkbox"/> 2 Point Pro <input type="checkbox"/> Quick Release					
Height	<input type="checkbox"/> LOW (10" Tall) *Backrest Height requires 12" or more *Available 10"-20" width	Width ( " )	<b>E2615</b>	\$	940
	<input type="checkbox"/> Medium (13" Tall) *Backrest Height requires 15" or more *Available 12"-20" width	Width ( " )	<b>E2615</b>	\$	959
	<input type="checkbox"/> Standard (16" Tall) *Backrest Height requires 18" or more *Available 14"-20" width	Width ( " )	<b>E2615</b>	\$	979
	<input type="checkbox"/> Tall (18" Tall) *Backrest Height requires 20" or more *Available 16"-20" width	Width ( " )	<b>E2615</b>	\$	998
<input type="checkbox"/> Add Privacy Flap	<input type="checkbox"/> X-Tall (20" Tall) *Backrest Height requires 22" or more *Available 16"-20" width	Width ( " )	<b>E2615</b>	\$	1,019
<b>(\$80 up charge)</b>	<input type="checkbox"/> Custom Size ( " Tall) x ( " width) . . . . .		<b>E2615</b>	\$	CFP
<b>ADI LATERAL SUPPORTS ( Lateral Supports are compatible with only active 2.5" ADI positioning back. )</b>					
<input type="checkbox"/> Stationary Pad	Pad Size <input type="checkbox"/> Small (3" H x 3" D) <input type="checkbox"/> Medium(3" H x 4" D) <input type="checkbox"/> Large(4.5" H x 4.5" D) <input type="checkbox"/> Large(4" H x 6" D)				
	<input type="checkbox"/> Pair . . . . .				\$ 422
	<input type="checkbox"/> Left side only or <input type="checkbox"/> Right side only . . . . .				\$ 211
<input type="checkbox"/> Swing-Out	Pad Size <input type="checkbox"/> Small (3" H x 3" D) <input type="checkbox"/> Medium(3" H x 4" D) <input type="checkbox"/> Large(4.5" H x 4.5" D) <input type="checkbox"/> Large(4" H x 6" D)				
	<input type="checkbox"/> Pair . . . . .				\$ 688
	<input type="checkbox"/> Left side only or <input type="checkbox"/> Right side only . . . . .				\$ 344
<b>OTHER</b>					
<input type="checkbox"/> ADI Transfer Board	<input type="checkbox"/> 21" (ADV21) <input type="checkbox"/> 24" (ADV24) <input type="checkbox"/> 29" (ADV29) . . . . .				\$ 82
<input type="checkbox"/> ADI Push and Transfer Gloves with Leather (one size)(ADGL) . . . . .					\$ 110
<input type="checkbox"/> ADI Push and Transfer Gloves with Rubber Grip (one size) (ADG) . . . . .					\$ 110
<input type="checkbox"/> ADI Carbon Solid Seat (Wide: 18" Max, Depth: 20" ) ✘ ONLY AVAILABLE WITH COLOURS NON-REMOVABLE SIDE GUARDS					\$ 827
<b>VARILITE® Seating Systems Available</b>					CFP
Please visit for all options <a href="http://www.varilite.com">www.varilite.com</a>					
NOTE					