

DEALER		COLOURS INFORMATION For Office Use Only	
Dealer:		Order Date:	S/N:
Account:	P.O.#:		
Ordered By:			
Customer Name:			
Customer Weight:			

CHAIR INFORMATION	MSRP PRICING
<b>RAZOR BLADE all terrain HCPC K0005</b> <b>Fixed FSH-RSH</b> <b>Max. Capacity 250Lbs</b> <b>Main Frame : ZK55 &amp; ZK60 High Grade A7000 Series Aluminum</b> NOTE <b>Main Frame : Lifetime Warranty(5 YEARS)</b> *See warranty policy	Base Wheel Chair Price <b>K0005</b> \$ 2,832 Total Section <b>A</b> \$ Total Section <b>B</b> \$ Total Section <b>C Custom Parts Color</b> \$ Total Section <b>D</b> \$ Total Section <b>E</b> \$ Total Section <b>F</b> \$ Total Section <b>G</b> \$ Total Section <b>H</b> \$ ORDER GRAND TOTAL \$

**A FRAME COLORS & PARTS COLORS**

<input type="checkbox"/> Neon Red <input type="checkbox"/> Neon Yellow <input type="checkbox"/> Brass Metallic <input type="checkbox"/> Tiffany Blue <input type="checkbox"/> Shocker Yellow <input type="checkbox"/> Sparkle Burgundy	
<b>Powder-Coated</b> <input type="checkbox"/> Gloss Black <input type="checkbox"/> Twilight Flake <input type="checkbox"/> Yellow <input type="checkbox"/> Magenta <input type="checkbox"/> Fire Engine Red <input type="checkbox"/> White <input type="checkbox"/> Candy Blue <input type="checkbox"/> Candy Purple <input type="checkbox"/> Candy Green <input type="checkbox"/> Candy Red <input type="checkbox"/> Candy Raspberry <input type="checkbox"/> Cobalt Blue <input type="checkbox"/> Matte Gray <input type="checkbox"/> Matte Purple <input type="checkbox"/> Matte Blue <input type="checkbox"/> Matte Green <input type="checkbox"/> Matte Black <input type="checkbox"/> Matte Red <input type="checkbox"/> Neon Green <input type="checkbox"/> Mellon Yellow <input type="checkbox"/> Gun Smoke Silver <input type="checkbox"/> Blue Lilac <input type="checkbox"/> Reed Green <input type="checkbox"/> Granny Sparkle Green <input type="checkbox"/> Sparkle Sky Blue	\$ STD
<b>Special</b> <input type="checkbox"/> Polished	\$ 920
<b>Please see Section C</b>	
<b>STD Color</b> Black Color (*Suspension Springs-Silver Color Only . . . . .)	\$ STD
<b>Custom Color Main Bolt on Parts One Color Package</b> <input type="checkbox"/> Powder-Coated (    ) . . . . . Including: Backrest, Foot Plate, Footrest Rings, Backrest Brackets, Saddle Stops, <input type="checkbox"/> Polished . . . . . Forks & Knurl Nuts, Caps, Front Suspension Springs , <input type="checkbox"/> 24 karat Gold . . . . .	\$ 575 \$ 863 \$ CFP

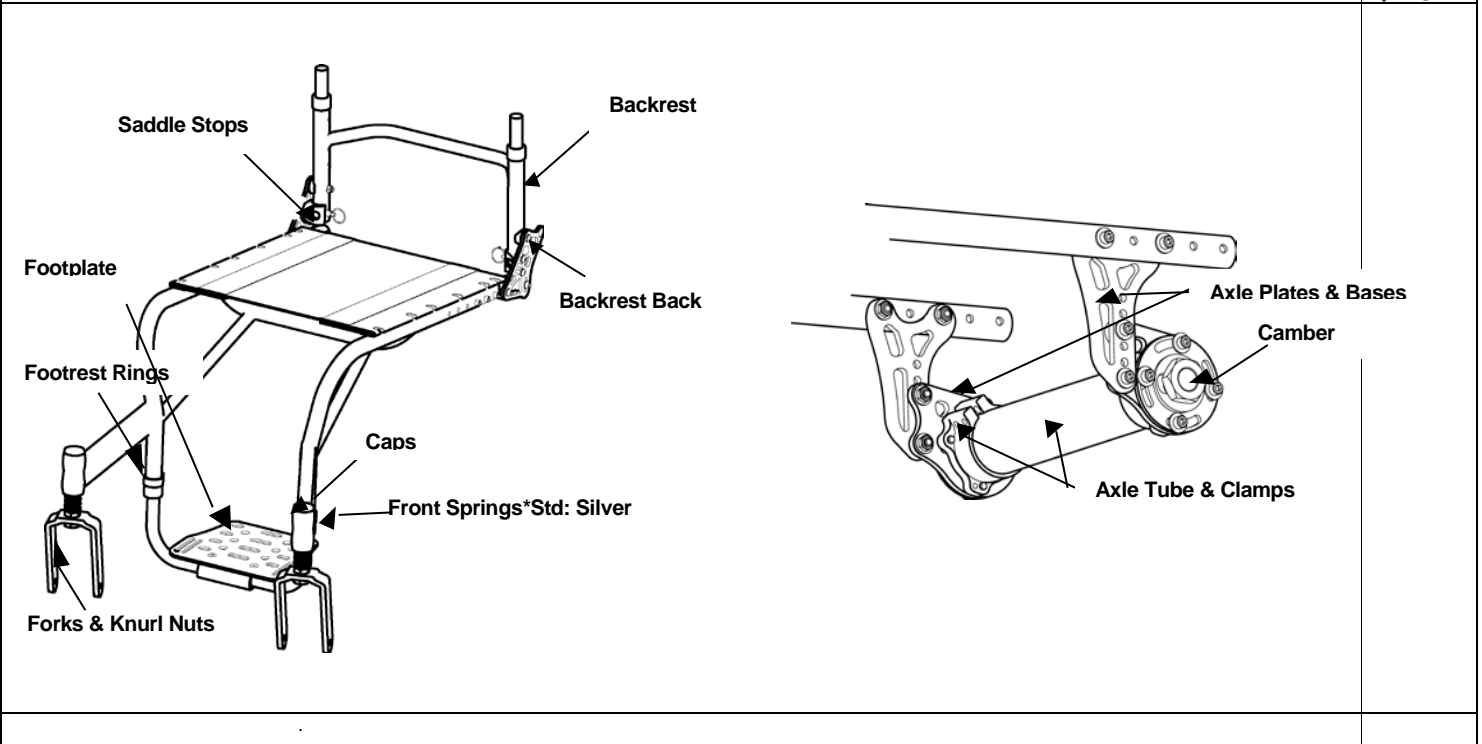

Caster Size	D (Approximately)
3" Caster	1.5"
4" Caster	2.0"
5" Caster	3.0"
8" Air Caster	5.5"

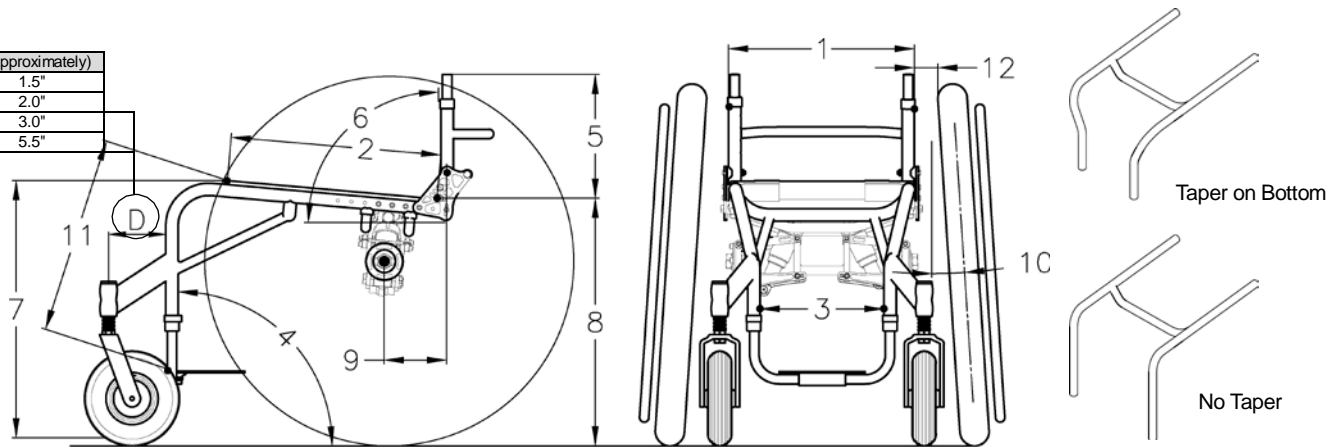

<b>1. SEAT WIDTH</b>	<input type="checkbox"/> 13" <input type="checkbox"/> 14" <input type="checkbox"/> 15" <input type="checkbox"/> 16" <input type="checkbox"/> 17" <input type="checkbox"/> 18" <input type="checkbox"/> 19" . . . . .	\$ STD							
<b>2. SEAT DEPTH</b> * Only Choose One Option	<input type="checkbox"/> <b>Net Seat Depth</b> <input type="checkbox"/> 13" <input type="checkbox"/> 14" <input type="checkbox"/> 15" <input type="checkbox"/> 16" <input type="checkbox"/> 17" <input type="checkbox"/> 18" <input type="checkbox"/> 19" . . . . . \$ STD <input type="checkbox"/> 20" . . . . . <b>E2203</b> \$ 345								
	<input type="checkbox"/> <b>Depth Adj. Frame</b> <input type="checkbox"/> <b>Short Frame</b> (16" Depth) Set at <input type="checkbox"/> 13" <input type="checkbox"/> 14" <input type="checkbox"/> 15" <input type="checkbox"/> 16" . . . . . \$ STD <input type="checkbox"/> <b>Long Frame</b> (19" Depth) Set at <input type="checkbox"/> 16" <input type="checkbox"/> 17" <input type="checkbox"/> 18" <input type="checkbox"/> 19" \$ STD								
	<input type="checkbox"/> <b>Aluminum Seat Pan</b> \$ 282 <input type="checkbox"/> <b>Positioning Frame</b> Add (   " ) . . . . . \$ NCO								
	<input type="checkbox"/> <b>Ergo Seat Tubing Depth</b> (   " ) . . . . . \$ 230 *Measurement must be 2.5" longer than your Center of Gravity								
<b>3. FOOTREST WIDTH</b>	<input type="checkbox"/> <b>STD</b> (Seat Width Minus 5") <input type="checkbox"/> <b>Taper on Bottom Frame only</b> . . . . . \$ STD <input type="checkbox"/> <b>Custom</b> (   " ) <input type="checkbox"/> <b>Taper on Bottom Frame only</b> . . . . . \$ NCO <input type="checkbox"/> <b>No Taper</b> (Seat Width Minus 2") . . . . . \$ STD								
	<b>FOOT PLATE STYLE</b> <input type="checkbox"/> <b>Standard single loop</b> with adjust. height & angle. STD Foot Plate . . . . . \$ STD <input type="checkbox"/> <b>Single Flip-Back-single loop</b> (no riser avail) with adjust. height & angle. STD Foot Plate . . . . . <b>K0040</b> \$ 173								
	STD Foot Plate Size Chart <table border="1" style="display: inline-table; margin-left: 20px;"> <thead> <tr> <th>Your Footrest Width</th> <th>Foot Plate Size</th> </tr> </thead> <tbody> <tr> <td>8.5"-10.0"</td> <td>W6.5"xD5"</td> </tr> <tr> <td>10.5"-13.0"</td> <td>W8.5"xD6.5"</td> </tr> <tr> <td>13.5"-17.0"</td> <td>W11"xD6.5"</td> </tr> </tbody> </table>	Your Footrest Width	Foot Plate Size	8.5"-10.0"	W6.5"xD5"	10.5"-13.0"	W8.5"xD6.5"	13.5"-17.0"	W11"xD6.5"
Your Footrest Width	Foot Plate Size								
8.5"-10.0"	W6.5"xD5"								
10.5"-13.0"	W8.5"xD6.5"								
13.5"-17.0"	W11"xD6.5"								
<b>CUSTOM FOOT PLATE</b>	<input type="checkbox"/> <b>Custom Foot Plate.</b> with adjust. height & angle . . . . . (   " ) \$ 100 *Available Solid Plate Only *Measurement must be 2.5" shorter than your Footrest Width								
	<input type="checkbox"/> <b>Custom Tubular Footrest</b> . . . . . \$ 288 *Measurement must be 2.5" shorter than your Footrest Width <input type="checkbox"/> <b>With ABS Foot Plate (\$75 up charge)</b>								
<b>4. FRAME ANGLE</b>	<input type="checkbox"/> 75° <input type="checkbox"/> 80° <input type="checkbox"/> 85° <input type="checkbox"/> 90° to the ground . . . . . \$ STD <input type="checkbox"/> <b>Custom</b> (   ° ) to the ground . . . . . \$ NCO								

<b>5. BACKREST HEIGHT</b>	<input type="checkbox"/> 8" <input type="checkbox"/> 9" <input type="checkbox"/> 10" <input type="checkbox"/> 11" <input type="checkbox"/> 12" <input type="checkbox"/> 13" <input type="checkbox"/> 14" <input type="checkbox"/> 15" <input type="checkbox"/> 16" <input type="checkbox"/> 17" <input type="checkbox"/> 18"	\$ STD																																							
* Rigidizer bar 3.25" deep std.																																									
<b>TYPE</b>	<input type="checkbox"/> <b>Locking mechan.</b> with adjust. height & angle .....	\$ STD																																							
	<input type="checkbox"/> <b>Double Locking mechan.</b> with adjust. height & angle .....	\$ 29																																							
	<input type="checkbox"/> <b>Folding with adjust.</b> height & angle .....	\$ NCO																																							
<b>CUSTOM</b>	<input type="checkbox"/> <b>Welded Backrest</b> Angle Set at (                    ") to the ground *Non Folding Backrest .....	\$ 173																																							
	<input type="checkbox"/> <b>Welded Side Guards</b> *w / Welded Backrest only .....	\$ 518																																							
	<input type="checkbox"/> <b>Custom Backrest</b> ..... (ie: double rigidizer bars, custom depth, custom height, etc)	\$ 173																																							
<b>6. BACKREST ANGLE</b>	Set at (                    °) to the ground *STD 90° .....	\$ STD																																							
<b>7. FRONT SEAT HEIGHT</b>	<input type="checkbox"/> 17.0" <input type="checkbox"/> 17.5" <input type="checkbox"/> 18.0" <input type="checkbox"/> 18.5" <input type="checkbox"/> 19.0" <input type="checkbox"/> 19.5" <input type="checkbox"/> 20.0" <input type="checkbox"/> 20.5" <input type="checkbox"/> 21.0"	\$ STD																																							
Front Seat Height Ranges																																									
<table border="1" style="margin: auto; border-collapse: collapse;"> <thead> <tr> <th style="padding: 5px;">Caster Wheel Size</th> <th style="padding: 5px;">Front Seat Height</th> </tr> </thead> <tbody> <tr> <td style="padding: 5px;">3" Caster</td> <td style="padding: 5px;">17.0" - 19.5"</td> </tr> <tr> <td style="padding: 5px;">4" Caster</td> <td style="padding: 5px;">17.0" - 20.0"</td> </tr> <tr> <td style="padding: 5px;">5" Caster</td> <td style="padding: 5px;">17.0" - 21.0"</td> </tr> <tr> <td style="padding: 5px;">8" Air Caster</td> <td style="padding: 5px;">18.0" - 21.0"</td> </tr> </tbody> </table>			Caster Wheel Size	Front Seat Height	3" Caster	17.0" - 19.5"	4" Caster	17.0" - 20.0"	5" Caster	17.0" - 21.0"	8" Air Caster	18.0" - 21.0"																													
Caster Wheel Size	Front Seat Height																																								
3" Caster	17.0" - 19.5"																																								
4" Caster	17.0" - 20.0"																																								
5" Caster	17.0" - 21.0"																																								
8" Air Caster	18.0" - 21.0"																																								
<b>8. REAR SEAT HEIGHT</b>	<input checked="" type="checkbox"/> 14.5" <input checked="" type="checkbox"/> 15.0" <input checked="" type="checkbox"/> 15.5" <input checked="" type="checkbox"/> Not Available w / Air Ride System <input type="checkbox"/> 16.0" <input type="checkbox"/> 16.5" <input type="checkbox"/> 17.0" <input type="checkbox"/> 17.5" <input type="checkbox"/> 18.0" <input type="checkbox"/> 18.5" <input type="checkbox"/> 19.0" <input checked="" type="checkbox"/> 19.5" *The rear seat heights are impacted by the size of your rear tire.	\$ STD																																							
<input type="checkbox"/> <b>w/ Colours Air Ride System</b> Rear Seat Height Option .....																																									
*Including ;Fox Racing Shox 300 HP Pump																																									
<input type="checkbox"/> <b>OMIT AIR PRO KIT = \$350</b> help shocks better perform																																									
<table style="width:100%; border-collapse: collapse;"> <tr> <td style="width: 30%; padding: 5px;"> <table border="1" style="width:100%; border-collapse: collapse;"> <thead> <tr> <th colspan="2" style="padding: 5px;">STD Rear Seat Height Ranges</th> </tr> <tr> <th style="padding: 5px;">Rear Tire Size</th> <th style="padding: 5px;">Rear Seat Height</th> </tr> </thead> <tbody> <tr><td style="padding: 5px;">24"x1"(540)</td><td style="padding: 5px;">14.5"- 18.0"</td></tr> <tr><td style="padding: 5px;">24"x1 3/8"(540)</td><td style="padding: 5px;">15.0"- 18.0"</td></tr> <tr><td style="padding: 5px;">25"x1"(559)</td><td style="padding: 5px;">15.5"- 18.0"</td></tr> <tr><td style="padding: 5px;">24"x2"(540)</td><td style="padding: 5px;">15.5"- 18.5"</td></tr> <tr><td style="padding: 5px;">26"x1"(590)</td><td style="padding: 5px;">15.5"- 19.0"</td></tr> <tr><td style="padding: 5px;">25"x1.95"(559)</td><td style="padding: 5px;">16.0"- 19.0"</td></tr> <tr><td colspan="2" style="padding: 5px; text-align: center;">*No Custom Modifications</td></tr> </tbody> </table> </td> <td style="width: 30%; padding: 5px;"> <table border="1" style="width:100%; border-collapse: collapse;"> <thead> <tr> <th colspan="2" style="padding: 5px;">Rear Seat Height Ranges w/ Air Ride System</th> </tr> <tr> <th style="padding: 5px;">Rear Tire Size</th> <th style="padding: 5px;">Rear Seat Height</th> </tr> </thead> <tbody> <tr><td style="padding: 5px;">24"x1"(540)</td><td style="padding: 5px;">16.0"- 18.5"</td></tr> <tr><td style="padding: 5px;">24"x1 3/8"(540)</td><td style="padding: 5px;">16.5"- 19.0"</td></tr> <tr><td style="padding: 5px;">25"x1"(559)</td><td style="padding: 5px;">16.5"- 19.0"</td></tr> <tr><td style="padding: 5px;">24"x2"(540)</td><td style="padding: 5px;">17.0"- 19.5"</td></tr> <tr><td style="padding: 5px;">26"x1"(590)</td><td style="padding: 5px;">17.0"- 19.5"</td></tr> <tr><td style="padding: 5px;">25"x1.95"(559)</td><td style="padding: 5px;">17.5"- 19.5"</td></tr> <tr><td colspan="2" style="padding: 5px; text-align: center;">*No Custom Modifications</td></tr> </tbody> </table> </td> <td style="width: 40%; padding: 5px;"> <b>REAR SUSPENSION RATING</b>  <input type="checkbox"/> Set up 50psi (For 80 lbs-110 lbs weight)  <input type="checkbox"/> Set up 60psi (For 110 lbs-140 lbs weight)  <input type="checkbox"/> Set up 80psi (For 140 lbs-170 lbs weight)  <input type="checkbox"/> Set up 100psi (For 170 lbs-200 lbs weight)  <input type="checkbox"/> Set up 120psi (For 200 lbs-230 lbs weight)  <input type="checkbox"/> Set up 150psi (For 230 lbs-250 lbs weight) </td> </tr> </table>			<table border="1" style="width:100%; border-collapse: collapse;"> <thead> <tr> <th colspan="2" style="padding: 5px;">STD Rear Seat Height Ranges</th> </tr> <tr> <th style="padding: 5px;">Rear Tire Size</th> <th style="padding: 5px;">Rear Seat Height</th> </tr> </thead> <tbody> <tr><td style="padding: 5px;">24"x1"(540)</td><td style="padding: 5px;">14.5"- 18.0"</td></tr> <tr><td style="padding: 5px;">24"x1 3/8"(540)</td><td style="padding: 5px;">15.0"- 18.0"</td></tr> <tr><td style="padding: 5px;">25"x1"(559)</td><td style="padding: 5px;">15.5"- 18.0"</td></tr> <tr><td style="padding: 5px;">24"x2"(540)</td><td style="padding: 5px;">15.5"- 18.5"</td></tr> <tr><td style="padding: 5px;">26"x1"(590)</td><td style="padding: 5px;">15.5"- 19.0"</td></tr> <tr><td style="padding: 5px;">25"x1.95"(559)</td><td style="padding: 5px;">16.0"- 19.0"</td></tr> <tr><td colspan="2" style="padding: 5px; text-align: center;">*No Custom Modifications</td></tr> </tbody> </table>	STD Rear Seat Height Ranges		Rear Tire Size	Rear Seat Height	24"x1"(540)	14.5"- 18.0"	24"x1 3/8"(540)	15.0"- 18.0"	25"x1"(559)	15.5"- 18.0"	24"x2"(540)	15.5"- 18.5"	26"x1"(590)	15.5"- 19.0"	25"x1.95"(559)	16.0"- 19.0"	*No Custom Modifications		<table border="1" style="width:100%; border-collapse: collapse;"> <thead> <tr> <th colspan="2" style="padding: 5px;">Rear Seat Height Ranges w/ Air Ride System</th> </tr> <tr> <th style="padding: 5px;">Rear Tire Size</th> <th style="padding: 5px;">Rear Seat Height</th> </tr> </thead> <tbody> <tr><td style="padding: 5px;">24"x1"(540)</td><td style="padding: 5px;">16.0"- 18.5"</td></tr> <tr><td style="padding: 5px;">24"x1 3/8"(540)</td><td style="padding: 5px;">16.5"- 19.0"</td></tr> <tr><td style="padding: 5px;">25"x1"(559)</td><td style="padding: 5px;">16.5"- 19.0"</td></tr> <tr><td style="padding: 5px;">24"x2"(540)</td><td style="padding: 5px;">17.0"- 19.5"</td></tr> <tr><td style="padding: 5px;">26"x1"(590)</td><td style="padding: 5px;">17.0"- 19.5"</td></tr> <tr><td style="padding: 5px;">25"x1.95"(559)</td><td style="padding: 5px;">17.5"- 19.5"</td></tr> <tr><td colspan="2" style="padding: 5px; text-align: center;">*No Custom Modifications</td></tr> </tbody> </table>	Rear Seat Height Ranges w/ Air Ride System		Rear Tire Size	Rear Seat Height	24"x1"(540)	16.0"- 18.5"	24"x1 3/8"(540)	16.5"- 19.0"	25"x1"(559)	16.5"- 19.0"	24"x2"(540)	17.0"- 19.5"	26"x1"(590)	17.0"- 19.5"	25"x1.95"(559)	17.5"- 19.5"	*No Custom Modifications		<b>REAR SUSPENSION RATING</b> <input type="checkbox"/> Set up 50psi (For 80 lbs-110 lbs weight) <input type="checkbox"/> Set up 60psi (For 110 lbs-140 lbs weight) <input type="checkbox"/> Set up 80psi (For 140 lbs-170 lbs weight) <input type="checkbox"/> Set up 100psi (For 170 lbs-200 lbs weight) <input type="checkbox"/> Set up 120psi (For 200 lbs-230 lbs weight) <input type="checkbox"/> Set up 150psi (For 230 lbs-250 lbs weight)
<table border="1" style="width:100%; border-collapse: collapse;"> <thead> <tr> <th colspan="2" style="padding: 5px;">STD Rear Seat Height Ranges</th> </tr> <tr> <th style="padding: 5px;">Rear Tire Size</th> <th style="padding: 5px;">Rear Seat Height</th> </tr> </thead> <tbody> <tr><td style="padding: 5px;">24"x1"(540)</td><td style="padding: 5px;">14.5"- 18.0"</td></tr> <tr><td style="padding: 5px;">24"x1 3/8"(540)</td><td style="padding: 5px;">15.0"- 18.0"</td></tr> <tr><td style="padding: 5px;">25"x1"(559)</td><td style="padding: 5px;">15.5"- 18.0"</td></tr> <tr><td style="padding: 5px;">24"x2"(540)</td><td style="padding: 5px;">15.5"- 18.5"</td></tr> <tr><td style="padding: 5px;">26"x1"(590)</td><td style="padding: 5px;">15.5"- 19.0"</td></tr> <tr><td style="padding: 5px;">25"x1.95"(559)</td><td style="padding: 5px;">16.0"- 19.0"</td></tr> <tr><td colspan="2" style="padding: 5px; text-align: center;">*No Custom Modifications</td></tr> </tbody> </table>	STD Rear Seat Height Ranges		Rear Tire Size	Rear Seat Height	24"x1"(540)	14.5"- 18.0"	24"x1 3/8"(540)	15.0"- 18.0"	25"x1"(559)	15.5"- 18.0"	24"x2"(540)	15.5"- 18.5"	26"x1"(590)	15.5"- 19.0"	25"x1.95"(559)	16.0"- 19.0"	*No Custom Modifications		<table border="1" style="width:100%; border-collapse: collapse;"> <thead> <tr> <th colspan="2" style="padding: 5px;">Rear Seat Height Ranges w/ Air Ride System</th> </tr> <tr> <th style="padding: 5px;">Rear Tire Size</th> <th style="padding: 5px;">Rear Seat Height</th> </tr> </thead> <tbody> <tr><td style="padding: 5px;">24"x1"(540)</td><td style="padding: 5px;">16.0"- 18.5"</td></tr> <tr><td style="padding: 5px;">24"x1 3/8"(540)</td><td style="padding: 5px;">16.5"- 19.0"</td></tr> <tr><td style="padding: 5px;">25"x1"(559)</td><td style="padding: 5px;">16.5"- 19.0"</td></tr> <tr><td style="padding: 5px;">24"x2"(540)</td><td style="padding: 5px;">17.0"- 19.5"</td></tr> <tr><td style="padding: 5px;">26"x1"(590)</td><td style="padding: 5px;">17.0"- 19.5"</td></tr> <tr><td style="padding: 5px;">25"x1.95"(559)</td><td style="padding: 5px;">17.5"- 19.5"</td></tr> <tr><td colspan="2" style="padding: 5px; text-align: center;">*No Custom Modifications</td></tr> </tbody> </table>	Rear Seat Height Ranges w/ Air Ride System		Rear Tire Size	Rear Seat Height	24"x1"(540)	16.0"- 18.5"	24"x1 3/8"(540)	16.5"- 19.0"	25"x1"(559)	16.5"- 19.0"	24"x2"(540)	17.0"- 19.5"	26"x1"(590)	17.0"- 19.5"	25"x1.95"(559)	17.5"- 19.5"	*No Custom Modifications		<b>REAR SUSPENSION RATING</b> <input type="checkbox"/> Set up 50psi (For 80 lbs-110 lbs weight) <input type="checkbox"/> Set up 60psi (For 110 lbs-140 lbs weight) <input type="checkbox"/> Set up 80psi (For 140 lbs-170 lbs weight) <input type="checkbox"/> Set up 100psi (For 170 lbs-200 lbs weight) <input type="checkbox"/> Set up 120psi (For 200 lbs-230 lbs weight) <input type="checkbox"/> Set up 150psi (For 230 lbs-250 lbs weight)			
STD Rear Seat Height Ranges																																									
Rear Tire Size	Rear Seat Height																																								
24"x1"(540)	14.5"- 18.0"																																								
24"x1 3/8"(540)	15.0"- 18.0"																																								
25"x1"(559)	15.5"- 18.0"																																								
24"x2"(540)	15.5"- 18.5"																																								
26"x1"(590)	15.5"- 19.0"																																								
25"x1.95"(559)	16.0"- 19.0"																																								
*No Custom Modifications																																									
Rear Seat Height Ranges w/ Air Ride System																																									
Rear Tire Size	Rear Seat Height																																								
24"x1"(540)	16.0"- 18.5"																																								
24"x1 3/8"(540)	16.5"- 19.0"																																								
25"x1"(559)	16.5"- 19.0"																																								
24"x2"(540)	17.0"- 19.5"																																								
26"x1"(590)	17.0"- 19.5"																																								
25"x1.95"(559)	17.5"- 19.5"																																								
*No Custom Modifications																																									
<input type="checkbox"/> <b>w/ Colours Air Ride System</b> Rear Seat Height Option .....																																									
Black Color .....																																									
<input type="checkbox"/> Powder-Coated (                    ) (\$380 up charge)																																									
<input type="checkbox"/> Polished Aluminum (\$920 up charge)																																									
<b>9. CENTER OF GRAVITY</b>	<input checked="" type="checkbox"/> 1.5" <input checked="" type="checkbox"/> 2.0" <input type="checkbox"/> 2.5" <input type="checkbox"/> 3.0" <input type="checkbox"/> 3.5" <input type="checkbox"/> 4.0" <input type="checkbox"/> 4.5" <input type="checkbox"/> 5.5" <input type="checkbox"/> 6.0" <input checked="" type="checkbox"/> Not Available w / Net Seat Depth Frame	\$ STD																																							
<b>10. CAMBER ANGLE</b>	<input type="checkbox"/> 2° <input type="checkbox"/> 4° <input type="checkbox"/> 6° .....	\$ STD																																							
<b>11. FRONT OF SEAT SLING TO FRONT OF FOOTREST</b>	<input checked="" type="checkbox"/> 15.0" <input checked="" type="checkbox"/> 15.5" <input checked="" type="checkbox"/> 16.0" <input type="checkbox"/> 16.5" <input type="checkbox"/> 17.0" <input type="checkbox"/> 17.5" <input type="checkbox"/> 18.0" <input type="checkbox"/> 18.5" <input type="checkbox"/> 19.0" <input type="checkbox"/> 19.5" *Not Available w / 19.0" , 19.5" , 20.0" , 20.5" , 21.0" Front Seat Height *Measurement must be 1.5" shorter than your Front Seat Height	\$ STD																																							
<b>HIGH MOUNT</b> With Risers or Clamps	<input type="checkbox"/> 11.0" <input type="checkbox"/> 11.5" <input type="checkbox"/> 12.0" <input type="checkbox"/> 12.5" <input type="checkbox"/> 13.0" <input type="checkbox"/> 13.5" <input type="checkbox"/> 14.0" <input type="checkbox"/> 14.5" <input type="checkbox"/> 15.0" <input type="checkbox"/> 15.5" <input type="checkbox"/> 16.0" .....	\$ 75																																							
<b>12. INSIDE WHEEL CLEARANCE</b>	<input type="checkbox"/> 3/4" <input type="checkbox"/> 1" <input type="checkbox"/> 1 1/4" <input type="checkbox"/> 1 1/2" <input type="checkbox"/> 1 3/4" <input type="checkbox"/> 2" ..... *3/4" Inside wheel clearance not available with 2 degree camber. (with the exception of Y-360 wheels) *3/4" Inside wheel clearance not available with Armrest   *3/4" Inside wheel clearance not available with Bite Hub Locks	\$ STD																																							

## 1. SEAT WIDTH

Measure from outside of seat tube to the outside of the opposite seat tube.

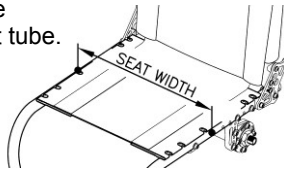

## 2. SEAT DEPTH

Measure from at the front bottom of backrest tube to the front edge of seat sling.

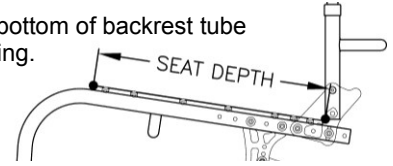

## 3. FOOTREST WIDTH

Measure from inside of front frame tube to inside of opposite front frame tube.

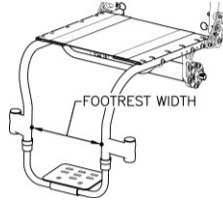

## 4. FRAME ANGLE

Measure angle frame front to floor.

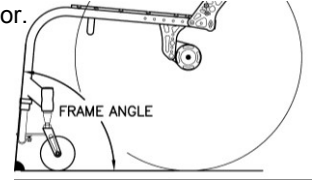

## 5. BACKREST HEIGHT

Measure from top of back post to seat sling at front bottom of backrest tube.

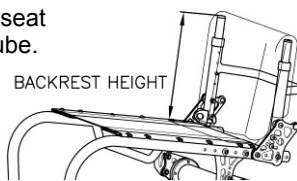

## 6. BACKREST ANGLE

Measure angle from front of back post to floor.

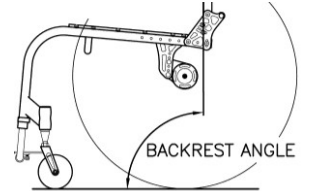

## 7. FRONT SEAT HEIGHT

Measure from floor to top of seat sling at front edge.

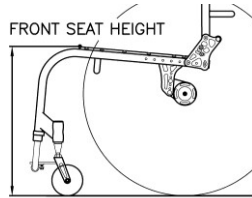

## 8. REAR SEAT HEIGHT

Measure from floor to top of seat sling at front bottom of backrest tube.

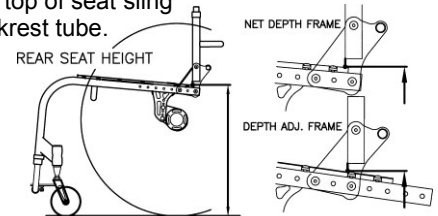

## 9. CENTER OF GRAVITY

Measure from center of back tube at the folding pivot to the center of the rear axle.

( If welding backrest is selected, Measure from center of back tube at the seat tube to the center of the rear axle. )

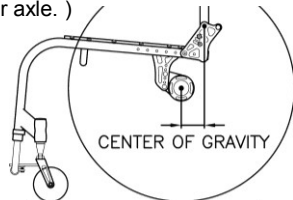

## 10. CAMBER ANGLE

Measure angle from wheel to vertical at floor.

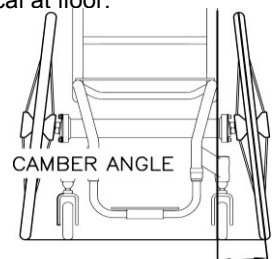

## 11. FRONT OF SEAT SLING TO FOOTREST

### ADULT CHAIR

Measure from top of seat sling at front edge to top of foot plate at front edge.

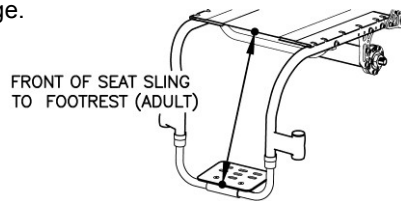

### PEDIATRIC CHAIR

Measure vertical from top of seat sling at front edge to top of foot plate.



## 12. INSIDE WHEEL CLEARANCE

Measure from outside of seat back tube to inside of rear tire.

( If side guards are selected, measure from outside of side guards to inside of rear tire.)

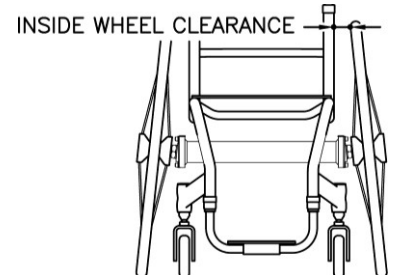

**C SPECIAL PARTS COLORS ( Please allow an additional 1-2 weeks delivery)**

PARTS COLORS	Neon Yellow	Brass Metallic	Sparkle Burgundy	Tiffany Blue	Shocker Yellow	
<b>Powder-Coated</b>	Gloss Black	Twilight Flake	Yellow	Magenta	Fire Engine Red	White
	Candy Blue	Candy Purple	Candy Green	Candy Red	Candy Raspberry	Cobalt Blue
	Matte Gray	Matte Purple	Matte Blue	Matte Green	Matte Black	Matte Red
		Orange Sparkle	Mellon Yellow	Gun Smoke Silver		
	Granny Sparkle Green	Sparkle Sky Blue	Reed Green	Blue Lilac		
<b>Special Colors</b>	Polished Aluminum					
	24 karat Gold Plated *Please allow an additional 4 weeks delivery					

**Please Choose the Color for each Part**

\*Parts not selected will be black color. (Suspension Spring: Silver Color)

\*Minimum 3 parts selected per order.

\*PC=Powder-Coated

**Saddle Stops**

- PC ( ) \$46
- Polished . . . . \$132
- Gold Plated . . . . \$CFP

**Backrest**

- PC ( ) \$144
- Polished . . . . \$259
- Gold Plated . . . . \$CFP

**Backrest Brackets**

- PC ( ) \$104
- Polished . . . . \$132
- Gold Plated . . . . \$CFP

**Foot Plate**

- PC ( ) \$52
- Polished . . . . \$104
- Gold Plated . . . . \$CFP

**Footrest Rings**

- PC ( ) \$23
- Polished . . . . \$46
- Gold Plated . . . . \$CFP

**Foot Plate Clamps**

- PC ( ) \$58
- Polished . . . . \$86
- Gold Plated . . . . \$CFP

**Axle Clamp**

- PC ( ) \$58
- Polished . . . . \$86
- Gold Plated . . . . \$CFP

**Axle Bases**

- PC ( ) \$58
- Polished . . . . \$86
- Gold Plated . . . . \$CFP

**Upper A-Arms**

- PC ( ) \$115
- Polished . . . . \$345
- Gold Plated . . . . \$CFP

**Lower A-Arms**

- PC ( ) \$115
- Polished . . . . \$322
- Gold Plated . . . . \$CFP

**Axle Tube**

- PC ( ) \$58
- Polished . . . . \$86
- Gold Plated . . . . \$CFP

**Axle Plates**

- PC ( ) \$75
- Polished . . . . \$98
- Gold Plated . . . . \$CFP

**Camber Plates**

- PC ( ) \$58
- Polished . . . . \$86
- Gold Plated . . . . \$CFP

**Suspension Main Frame**

- PC ( ) \$173
- Polished . . . . \$460
- Gold Plated . . . . \$CFP

**Caps**

- PC ( ) \$23
- Polished . . . . N/A
- Gold Plated . . . . N/A

**Front Springs**

- PC ( ) \$23
- Polished . . . . N/A
- Gold Plated . . . . N/A

**Forks & Knurl Nuts**

- PC ( ) \$75
- Polished . . . . \$104
- Gold Plated . . . . \$CFP

**Axle Receiver Holder**

- PC ( ) \$69
- Polished . . . . \$207
- Gold Plated . . . . \$CFP

**D COMPONENTS**

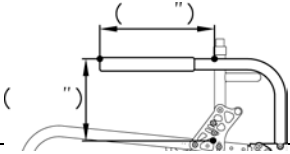
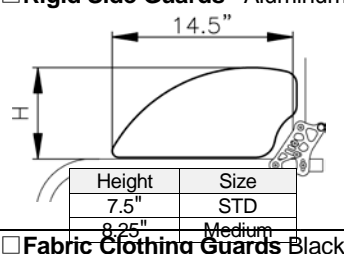
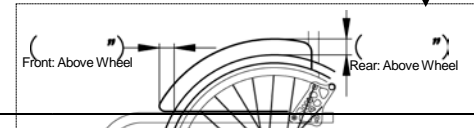
<b>WHEEL LOCKS</b>			
<input type="checkbox"/> New Solutions Push to Lock	<input type="checkbox"/> w/ 2" Extension Handle (\$80up charge)		\$ STD
<input type="checkbox"/> Gallop Push to Lock / Anodized			\$ STD
<input type="checkbox"/> Question Mark Style Scissor			\$ 70
<input type="checkbox"/> NEW Compact Scissor Lock / Anodized Black Only			\$ 127
<input type="checkbox"/> Gallop Scissor Lock / Anodized			\$ 127
<b>PUSH HANDLES</b>		<b>*If you are ordering push handles, You must select the backrest locking mechanism.</b>	
<input type="checkbox"/> Integrated w/Fixed Backrest Height / Anodized Black Only			\$ STD
<input type="checkbox"/> Bolt-on / Anodized Black Only	Specify Height from floor -( )"		\$ 163
<input type="checkbox"/> Bolt-on w/Quick Release / Anodized Black Only	Specify Height from floor -( )"		\$ 219
<input type="checkbox"/> NEW Height Adj. / Anodized Black Only	Specify Maximum height from floor -( )"		\$ 339
<b>NEW ARM RESTS</b>		Anodized Black Only	
<input type="checkbox"/> Fixed Tubular Armrest	Adj. Angle and Height	Height from seat sling Set at : <input type="checkbox"/> 8" <input type="checkbox"/> 9" <input type="checkbox"/> 10" <input type="checkbox"/> 11" <input type="checkbox"/> 12" E0973	\$ 288
<input type="checkbox"/> Swing Away Tubular Armrest	Adj. Angle and Height	Height from seat sling Set at : <input type="checkbox"/> 8" <input type="checkbox"/> 9" <input type="checkbox"/> 10" <input type="checkbox"/> 11" <input type="checkbox"/> 12" E0973	\$ 288
<input type="checkbox"/> Flip-Up Armrest	<input type="checkbox"/> w/Fixed Tubular Armrest	Height from seat sling Set at : <input type="checkbox"/> 8" <input type="checkbox"/> 9" <input type="checkbox"/> 10" <input type="checkbox"/> 11" <input type="checkbox"/> 12" E0973	\$ 288
	Adj. Angle <input type="checkbox"/> w/ Swing Away Tubular Armrest	Height from seat sling Set at : <input type="checkbox"/> 8" <input type="checkbox"/> 9" <input type="checkbox"/> 10" <input type="checkbox"/> 11" <input type="checkbox"/> 12" E0973	\$ 288
<input type="checkbox"/> Custom Length & Height (\$150 up charge)		*Specify Height & Length →	
			
<b>ANTI-TIPPERS</b>			
<input type="checkbox"/> Removable Anti-tipper(pair) Anodized Black Only		E0971	\$ 253
<input type="checkbox"/> Press Release Removable Anti-tipper(pair)		E0971	\$ 288
<b>SIDE GUARDS</b>			
<input type="checkbox"/> Rigid Side Guards - Black ABS	<input type="checkbox"/> Non-Removable <input type="checkbox"/> Removable <input type="checkbox"/> Removable w/Hole (\$12 up charge)		\$ 163
Color: Black Only	Size: <input type="checkbox"/> STD <input type="checkbox"/> Medium <input type="checkbox"/> Cut to Wheel (\$98 up charge)	Measurement	
<input type="checkbox"/> Rigid Side Guards - Aluminum	<input type="checkbox"/> Non-Removable <input type="checkbox"/> Removable		\$ 227
	Size: <input type="checkbox"/> Medium Only <input type="checkbox"/> Cut to Wheel (\$98 up charge)	Measurement	
	Color <input type="checkbox"/> Black (STD) <input type="checkbox"/> Pol. Aluminum (STD) <input type="checkbox"/> Powder Coated ( ) (\$120 up charge) <input type="checkbox"/> Gold Plate (+CFP)		
<input type="checkbox"/> Fabric Clothing Guards Black Nylon w/Velcro			\$ 94
			
<b>SEAT CUSHION</b> <b>-*Please see section for other cushion choices.-</b>			
<input type="checkbox"/> Foam Cushion	w/Nylon Black Cover Thickness <input type="checkbox"/> 1" <input type="checkbox"/> 2" <input type="checkbox"/> 3" <input type="checkbox"/> 4"		\$ CFP
<input type="checkbox"/> Custom Cushion Cover (Std. Foam Cushion Only) -Select Fabric ( ) (\$90 up charge)			
<b>ACCESSORIES</b>			
<input type="checkbox"/> Frame Protectors / Black Leather/Zipper Type			\$ 94
<input type="checkbox"/> Gel Ovation Protector Wraps Gel Silicone			\$ 115
<input type="checkbox"/> E0978 Seat Belt w/Auto Buckle (BP) 1.5" Black Belt Only		E0978	\$ 98
<input type="checkbox"/> Tie Down Brackets 4pcs.			\$ 242
<input type="checkbox"/> Calf Strap <input type="checkbox"/> Black <input type="checkbox"/> Matching Fabric (\$55 up charge) -Select Fabric ( )			\$ 29
<input type="checkbox"/> Bodypoint Padded Calf Strap <input type="checkbox"/> (14"-16" footrest width) <input type="checkbox"/> (16"-20" footrest width) <input type="checkbox"/> (20"-24" footrest)		\$77 \$83 \$89	
<input type="checkbox"/> Hanging Zipper Pouch <input type="checkbox"/> Black <input type="checkbox"/> Matching Fabric (\$60) or <input type="checkbox"/> Leather (\$75) Custom Size Width: Length:			\$ 75
<input type="checkbox"/> Matching Fabric on Padded Side Guards -Select Fabric ( )			\$ 242
<b>UPHOLSTERY CHOICE &amp; COLOR</b>		<b>*Positioning Back Available. Please see Section E</b>	
<input type="checkbox"/> Standard Adjustable Height Backrest (Black)			\$ STD
<input type="checkbox"/> Adjustable Tension Backrest Black Only (*Not available with 8" Backrest Height)			\$ 150
Options	<input type="checkbox"/> Fun Fabric: For Std. or Adj. Style (Choose From Choices on Page 7 and write below) (\$ 80 up charge)		
	<input type="checkbox"/> Backrest Leather Trim (outside panels) (\$ up charge)		\$ CFP

FABRIC CHOICE SHEET

1. Camouflage Girls

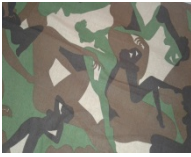

2. Purple Zebra



3. Silver Grey Snake



5. Laughing Skulls



6. Purple Snake



7. Sweetheart Pinup Girls



9. Blue Flames

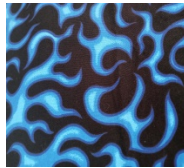

10. Arctic Camo



11. Furry Friends



12. Supercars



13. Urban Camo

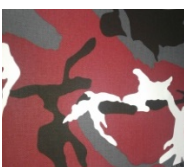

14. Superbikes



15. Sizzle Flames



16. Hot Rod Flames



17. Skulls w/ Attitude



18. Sweet Pink

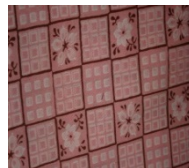

19. Heart and Soul



20. Home Run



21. Fuzzy Giraffe

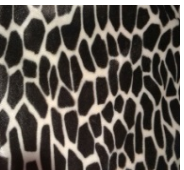

22. Cheetah



23. Paperweight Cobalt



24. Zig Zag Dots



25. Smokey Tribal Flames

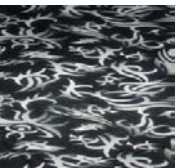

26. Rose and Rebellion



27. Tattoo Adventure(Cream

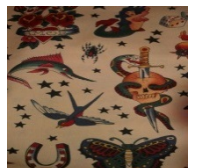

28. Red Tribal Flames

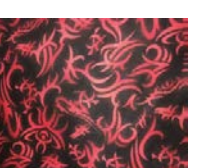

29. Tattoo Adventure(Black)

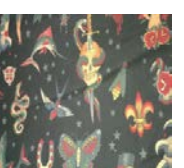

30. Butterfly Bandana

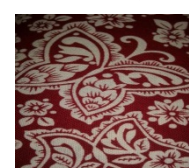

31. Tatsu Dragon

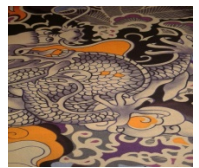



**E TIRES, CASTERS, & FORKS**

TIRES						
<input type="checkbox"/>	<b>Primo High Pressure Tire</b>	<input type="checkbox"/> 24"x1" <input type="checkbox"/> 25"x1" <input type="checkbox"/> 26"x1"	Gray Tire w/ black line	.....	<b>E2211/E2212</b>	\$ STD
<input type="checkbox"/>	<b>Primo High Pressure Tire</b>	<input type="checkbox"/> 24"x1" <input type="checkbox"/> 25"x1" or <input type="checkbox"/> 26"x1"	<input type="checkbox"/> Blue <input type="checkbox"/> Red	.....	<b>E2211/E2212</b>	\$ 98
<input type="checkbox"/>	<b>Low Pressure Tire</b>	<input type="checkbox"/> 24"x1-3/8" or <input type="checkbox"/> 26"x1-3/8"	Gray Only	.....	<b>E2211/E2212</b>	\$ STD
<input type="checkbox"/>	<b>Schwalbe Marathon Plus High Pressure Tire</b>	<input type="checkbox"/> 24"x1", <input type="checkbox"/> 25"x1" or <input type="checkbox"/> 26"x1"	Black Only	.....	<b>E2211/E2212</b>	\$ 148
<input type="checkbox"/>	<b>Solid Tire</b>	<input type="checkbox"/> 24"x1" <input type="checkbox"/> 25"x1" Black		.....	<b>E2218</b>	\$ 190
<input type="checkbox"/>	<b>Solid Tire</b>	<input type="checkbox"/> 26"x1 Dark Grey		.....	<b>E2218</b>	\$ 155
<input type="checkbox"/>	<b>Moderate V-Track Knobby Tire</b>	24"x1-3/8" (37-540)	Gray Only	.....	<b>E2211/E2212</b>	\$ 135
<input type="checkbox"/>	<b>Aggressive Knobby Tire</b>	24"x2" (50-540)	Gray Only <input type="checkbox"/> Blue Line <input type="checkbox"/> Red Line	.....	<b>E2211/E2212</b>	\$ 135
<input type="checkbox"/>	<b>Aggressive Knobby Tire</b>	26"x2" (50-559)	Gray Only <input type="checkbox"/> Blue Line <input type="checkbox"/> Red Line	.....	<b>E2211/E2212</b>	\$ 135
<input type="checkbox"/>	<b>Aggressive Knobby Tire</b>	24" x 1.95"(50-540)	Black Only	.....	<b>E2211/E2212</b>	\$ 135
<input type="checkbox"/>	<b>E2211 Bell Mountain Bike Tire</b>	in Flat Defense (559) 26" X 1.75 - 2.25	Black Only	.....	<b>E2211/E2212</b>	\$ 135
<input type="checkbox"/>	<b>Flat-Free Inserts</b>	For 24"x1-3/8" Tires Only		.....	<b>E2211/E2213</b>	\$ 135
CASTERS						
SIZE	TIRE WIDTH	HUB COLOR	TIRE COLOR	DESCRIPTION		
<input type="checkbox"/> 3"	1"	Black Hub	Black Tire Only	Polyurethane	<b>K0077</b>	\$ STD
<input type="checkbox"/> 3"	1"	Plastic Black Hub	Clear Tire Only	Lighted, Polyurethane	<b>A9900</b>	\$ 75
<input type="checkbox"/> 3"	1"	Red Hub	Red Tire Only	Polyurethane	<b>E2222</b>	\$ STD
<input type="checkbox"/> 3"	1"	Black Hub	Clear Tire Only	Polyurethane	<b>E2222</b>	\$ STD
<input type="checkbox"/> 3"	1"	Aluminum Silver Hub	Black Tire Only	Made By Frog Legs	<b>K0071</b>	\$ 190
<input type="checkbox"/> 3"	1"	Aluminum Black Hub	Black Tire Only	Made By Frog Legs	<b>E2222</b>	\$ 190
<input type="checkbox"/> 3"	1.5"	Aluminum Silver Hub	Black Tire Only	Soft Roll Made By Frog Legs	<b>E2222</b>	\$ 190
<input type="checkbox"/> 3"	1.5"	Aluminum Black Hub	Black Tire Only	Soft Roll Made By Frog Legs	<b>E2222</b>	\$ 190
<input type="checkbox"/> 4"	1 1/8"	Plastic Black Hub	Black Tire Only	Polyurethane Not Available with Narrow Frog Leg Forks	<b>E2222</b>	\$ STD
<input type="checkbox"/> 4"	1"	Plastic Black Hub	Clear Only	Lighted, Polyurethane	<b>E2221</b>	\$ 75
<input type="checkbox"/> 4"	1"	Aluminum Silver Hub	Black Tire Only	Made By Frog Legs	<b>E2214</b>	\$ 190
<input type="checkbox"/> 4"	1"	Aluminum Black Hub	Black Tire Only	Made By Frog Legs	<b>E2214</b>	\$ 190
<input type="checkbox"/> 4"	1.5"	Aluminum Silver Hub	Tire <input type="checkbox"/> Black <input type="checkbox"/> Blue <input type="checkbox"/> Red	Soft Roll Made By Frog Legs	<b>E1015</b>	\$ 190
<input type="checkbox"/> 4"	1.5"	Aluminum Black Hub	Black Tire Only	Soft Roll Made By Frog Legs	<b>E2214</b>	\$ 190
<input type="checkbox"/> 5"	1"	Composite Black	Black Tire Only	Polyurethane	<b>E2222</b>	\$ STD
<input type="checkbox"/> 5"	1"	Plastic Black Hub	Clear Tire Only	Lighted, Polyurethane	<b>A9900</b>	\$ 75
<input type="checkbox"/> 5"	1"	Aluminum Silver Hub	Black Tire Only	Made By Frog Legs	<b>A9900</b>	\$ 190
<input type="checkbox"/> 5"	1"	Aluminum Black Hub	Black Tire Only	Made By Frog Legs	<b>E2214</b>	\$ 190
<input type="checkbox"/> 5"	1.5"	Aluminum Silver Hub	Tire <input type="checkbox"/> Black <input type="checkbox"/> Blue <input type="checkbox"/> Red	Soft Roll Made By Frog Legs	<b>K0072</b>	\$ 190
<input type="checkbox"/> 5"	1.5"	Aluminum Black Hub	Black Tire Only	Soft Roll Made By Frog Legs	<b>E2222</b>	\$ 190
<input type="checkbox"/> 6"	1.5"	Aluminum Black Hub	Black Tire Only	Soft Roll Made By Frog Legs	<b>E2222</b>	\$ 213
<input type="checkbox"/> 6"	1.5"	Aluminum Silver Hub	Black Tire Only	Soft Roll Made By Frog Legs	<b>E2222</b>	\$ 213
<input type="checkbox"/> 8"	1.5"	Composite Black Hub	Black Tire Only	8" Air Caster w/Monster Fork		\$ 230
<input type="checkbox"/>	<input type="checkbox"/> 1"OR <input type="checkbox"/> 1.5"	Hub Color:	Tread Color:	Soft Roll Made By Frog Legs	<b>E2222</b>	\$ CFP
FORKS						
<input type="checkbox"/>	<b>Frog Leg Shields(4 pcs) Only for Frog Leg Forks</b>					\$ 28
<input type="checkbox"/>	<b>STD Aluminum Forks with Suspension</b>					\$ STD
	Springs Black Only					
	Extra Options for Aluminum Forks <input type="checkbox"/> Without Suspension Springs					<b>E1015</b> \$ NCO
	<input type="checkbox"/> With Quick Release Axles					<b>K0073</b> \$ 123
<input type="checkbox"/>	<b>Frog Leg Suspension Forks 1" Wide</b> (For 3", 4" x 1" width Caster and 5" STD Caster, 5" lighted Caster)					Not available with Quick Release Axle
	*User's Weight	Color	<input type="checkbox"/> Anodized Black <input type="checkbox"/> Anodized Silver		<b>E1015</b>	\$ 552
<input type="checkbox"/>	<b>Frog Leg Suspension Forks 1.5" Wide</b> (For 3", 4" x 1.5" width Caster and 5" x 1"& 5" x 1.5" Casters )					Not available with Quick Release Axle
	*User's Weight	Color	<input type="checkbox"/> Anodized Black <input type="checkbox"/> Anodized Silver		<b>E1015</b>	\$ 552



**F WHEELS**

WHEELS																		
<b>Wire Wheels</b>	<input type="checkbox"/> 24" (540) <input type="checkbox"/> 25" (599) ..... <input type="checkbox"/> 26" (590)	\$ NCO \$ 299 \$ 299																
<b>Y-360 Billet Wheels</b> *Max. Capacity 220Lbs *Camber 0-2" max *Not for Sports or Rugged use	<input type="checkbox"/> 25" (559) ..... Style <input type="checkbox"/> Saw Blade	\$ 1,300																
<b>Y-360 Billet Wheels MOD Style</b> *Max. Capacity 220Lbs *Camber 0-2" max *Not for Sports or Rugged use	<input type="checkbox"/> 25" (559) Only Style <input type="checkbox"/> Tribal Sun <input type="checkbox"/> Girls <input type="checkbox"/> Eagle <input type="checkbox"/> Holy Cross <input type="checkbox"/> Hono(Flames) ..... Specify Powder Coat Color for Insert Only ( ) *Choose from Frame Colors	\$ 1,550																
<b>Extra Options for</b> <input type="checkbox"/> Powder-Coated Spokes Only ( ) *Choose from Frame Colors <b>(\$250 up charge)</b>																		
<b>Spinergy Spox 18 Spokes</b> 	<input type="checkbox"/> 24" (540) <input type="checkbox"/> 25" (559) <input type="checkbox"/> 26" (590) Spoke Color <input type="checkbox"/> Black <input type="checkbox"/> Red <input type="checkbox"/> Yellow <input type="checkbox"/> Blue <input type="checkbox"/> White ..... With Silver Hub   With Black Hub   With Black Hub   With Black Hub   With Black Hub  <input type="checkbox"/> Custom Color Spoke Pattern <table border="1" style="display: inline-table; margin-left: 10px;"> <thead> <tr> <th colspan="2"></th> <th>Left Wheel</th> <th>Right Wheel</th> </tr> </thead> <tbody> <tr> <td>Spokes</td> <td>Inside</td> <td></td> <td></td> </tr> <tr> <td>Color</td> <td>Outside</td> <td></td> <td></td> </tr> <tr> <td>Hub Color</td> <td></td> <td><input type="checkbox"/> Black/<input type="checkbox"/> Silver</td> <td><input type="checkbox"/> Black/<input type="checkbox"/> Silver</td> </tr> </tbody> </table>			Left Wheel	Right Wheel	Spokes	Inside			Color	Outside			Hub Color		<input type="checkbox"/> Black/ <input type="checkbox"/> Silver	<input type="checkbox"/> Black/ <input type="checkbox"/> Silver	\$ 907  \$ 1,007
		Left Wheel	Right Wheel															
Spokes	Inside																	
Color	Outside																	
Hub Color		<input type="checkbox"/> Black/ <input type="checkbox"/> Silver	<input type="checkbox"/> Black/ <input type="checkbox"/> Silver															
<b>Spinergy LX 12 Spokes</b> 	<input type="checkbox"/> 24" (540) <input type="checkbox"/> 25" (559) <input type="checkbox"/> 26" (590) Spoke Color <input type="checkbox"/> Black <input type="checkbox"/> Red <input type="checkbox"/> Yellow <input type="checkbox"/> Blue With Silver Hub   With Black Hub   With Black Hub   With Black Hub <input type="checkbox"/> White <input type="checkbox"/> Neon Green <input type="checkbox"/> Pink <input type="checkbox"/> Orange With Black Hub   With Black Hub   With Black Hub   With Black Hub <input type="checkbox"/> Purple With Black Hub  <input type="checkbox"/> Custom Color Spoke Pattern <table border="1" style="display: inline-table; margin-left: 10px;"> <thead> <tr> <th colspan="2"></th> <th>Left Wheel</th> <th>Right Wheel</th> </tr> </thead> <tbody> <tr> <td>Spokes</td> <td>Inside</td> <td></td> <td></td> </tr> <tr> <td>Color</td> <td>Outside</td> <td></td> <td></td> </tr> <tr> <td>Hub Color</td> <td></td> <td><input type="checkbox"/> Black/<input type="checkbox"/> Silver</td> <td><input type="checkbox"/> Black/<input type="checkbox"/> Silver</td> </tr> </tbody> </table>			Left Wheel	Right Wheel	Spokes	Inside			Color	Outside			Hub Color		<input type="checkbox"/> Black/ <input type="checkbox"/> Silver	<input type="checkbox"/> Black/ <input type="checkbox"/> Silver	\$ 1,138  \$ 1,238
		Left Wheel	Right Wheel															
Spokes	Inside																	
Color	Outside																	
Hub Color		<input type="checkbox"/> Black/ <input type="checkbox"/> Silver	<input type="checkbox"/> Black/ <input type="checkbox"/> Silver															
<b>Spinergy X-Laced Sport Lite Extreme "XSLX" 24 Spokes</b> 	<input type="checkbox"/> 24" (540) <input type="checkbox"/> 25" (559) <input type="checkbox"/> 26" (590) Spoke Color <input type="checkbox"/> Black <input type="checkbox"/> Red <input type="checkbox"/> Yellow <input type="checkbox"/> Blue With Silver Hub   With Black Hub   With Black Hub   With Black Hub <input type="checkbox"/> White <input type="checkbox"/> Neon Green <input type="checkbox"/> Pink <input type="checkbox"/> Orange <input type="checkbox"/> Purple With Black Hub   With Black Hub   With Black Hub   With Black Hub   With Black Hub  <input type="checkbox"/> Custom Color Spoke Pattern <table border="1" style="display: inline-table; margin-left: 10px;"> <thead> <tr> <th colspan="2"></th> <th>Left Wheel</th> <th>Right Wheel</th> </tr> </thead> <tbody> <tr> <td>Spokes</td> <td>Inside</td> <td></td> <td></td> </tr> <tr> <td>Color</td> <td>Outside</td> <td></td> <td></td> </tr> <tr> <td>Hub Color</td> <td></td> <td><input type="checkbox"/> Black/<input type="checkbox"/> Silver</td> <td><input type="checkbox"/> Black/<input type="checkbox"/> Silver</td> </tr> </tbody> </table>			Left Wheel	Right Wheel	Spokes	Inside			Color	Outside			Hub Color		<input type="checkbox"/> Black/ <input type="checkbox"/> Silver	<input type="checkbox"/> Black/ <input type="checkbox"/> Silver	\$ 1,100  \$ 1,200
		Left Wheel	Right Wheel															
Spokes	Inside																	
Color	Outside																	
Hub Color		<input type="checkbox"/> Black/ <input type="checkbox"/> Silver	<input type="checkbox"/> Black/ <input type="checkbox"/> Silver															

Valid from 2022 Prices & Specifications Are Subject To Change Without Notice.

**Spinergy Sport Lite Extreme "SLX" 24 Spoke**



24" (540)    25" (559)    26" (590)  
 Spoke Color    Black    Red    Yellow    Blue  
                     With Silver Hub   With Black Hub   With Black Hub   With Black Hub  
 White    Neon Green    Pink    Orange    Purple  
                     With Black Hub   With Black Hub   With Black Hub   With Black Hub   With Black Hub

Custom Color Spoke Pattern

		Left Wheel	Right Wheel
Spokes	Inside		
	Outside		
Hub Color		<input type="checkbox"/> Black/ <input type="checkbox"/> Silver	<input type="checkbox"/> Black/ <input type="checkbox"/> Silver

\$ 1,060

\$ 1,160

**Spinergy Lite Extreme "XLX" X-Laced-12 Spoke**



24" (540)    25" (559)    26" (590)  
 Spoke Color    Black    Red    Yellow    Blue  
                     With Silver Hub   With Black Hub   With Black Hub   With Black Hub  
 White    Neon Green    Pink    Orange    Purple  
                     With Black Hub   With Black Hub   With Black Hub   With Black Hub   With Black Hub

Custom Color Spoke Pattern

		Left Wheel	Right Wheel
Spokes	Inside		
	Outside		
Hub Color		<input type="checkbox"/> Black/ <input type="checkbox"/> Silver	<input type="checkbox"/> Black/ <input type="checkbox"/> Silver

\$ 1,100

\$ 1,200

**Spinergy Blade "LXL" 18 Spoke**



24" (540)    25" (559)    26" (590)  
 Spoke Color    Black    Red    Yellow    Blue  
                     With Silver Hub   With Black Hub   With Black Hub   With Black Hub  
 White    Neon Green    Pink    Orange    Purple  
                     With Black Hub   With Black Hub   With Black Hub   With Black Hub   With Black Hub

Custom Color Spoke Pattern

		Left Wheel	Right Wheel
Spokes	Inside		
	Outside		
Hub Color		<input type="checkbox"/> Black	<input type="checkbox"/> Black

\$ 945

\$ 1,045

**HANDRIM**

<b>Type</b>	<input type="checkbox"/> Standard For 24", 25" or 26" Wheel Anodized Black	\$ STD
	<input type="checkbox"/> Vinyl Coated For 24", 25" & 26" Wheels Not available with Y-360 Billet Wheels . . . . .	\$ 180
	<input type="checkbox"/> Spinergy Silver Brushed Anodized For 24", 25" & 26" . . . . .	\$ 160
	<input type="checkbox"/> Natural Fit For 24", 25" & 26" Wheel	
	<input type="checkbox"/> Standard Grip (Not available with short tabs.) Not available with Y-360 Billet Wheels . . . . .	\$ 495
	<input type="checkbox"/> Super Grip (Not available with short tabs.) Not available with Y-360 Billet Wheels . . . . .	\$ 561
	<input type="checkbox"/> Without Thumb Grip (Not available with Y-360 Billet Wheels) . . . . .	\$ 294
	<input type="checkbox"/> Natural Fit(LT) For 24", 25" & 26" Wheel	
	<input type="checkbox"/> Standard Grip (Not available with short tabs.) Not available with Y-360 Billet Wheels . . . . .	\$ 547
	<input type="checkbox"/> Super Grip (Not available with short tabs.) Not available with Y-360 Billet Wheels . . . . .	\$ 614
	<input type="checkbox"/> Without Thumb Grip (Not available with Y-360 Billet Wheels) . . . . .	\$ 347
	<input type="checkbox"/> The Surge Handrims * Not available with Y-360 Billet Wheels . . . . .	\$ 481
	<input type="checkbox"/> The Surge Handrims (LT) * Not available with Y-360 Billet Wheels . . . . .	\$ 524
	<input type="checkbox"/> Spinergy Flex Rim Available only on Spinergy LX & XLX	\$ CFP
	<input type="checkbox"/> The Q-Grip Handrims : anti-slip, latex-free, neoprene coating * Not available with Y-360 Billet Wheels	\$ 472
	<input type="checkbox"/> OMIT HANDRIMS	\$ NCO

<b>TAB LENGTH</b>	<input type="checkbox"/> Long Tab ( STD inside clearance 3/4") Not available with Y-360 Billet Wheels * . . . . .	STD
	<input type="checkbox"/> Short Tab (Inside clearance 1/2") * Not available with Natural Fit Handrim with thumb grip . . . . .	\$ STD
	<input type="checkbox"/> Short Tab (Set closest to wheel cut off excess) * Not available with Y-360 wheel . . . . .	\$ 30

**G CHAIR OPTIONS 1 / 3**

SEAT CUSHION							
<b>SUPRACOR® WHEELCHAIR CUSHIONS</b>							
<b>Stimulite® Contoured Cushion</b> *Black Upholstery only  *Comes with Zipper Pouch <input type="checkbox"/> Extra Sensitive (\$35 up charge) <input type="checkbox"/> Sling Style Bottom (\$52 up charge) <input type="checkbox"/> Custom Size (\$- CFP) W(    " ) x D(    " ) <input type="checkbox"/> Extra Cover (\$104 up charge)	<input type="checkbox"/> W14"xD16" (CD1416)	.....	E2603 \$ 615				
	<input type="checkbox"/> W16"xD16" (CD1616)	.....	E2603 \$ 615				
	<input type="checkbox"/> W16"xD18" (CD1618)	.....	E2603 \$ 615				
	<input type="checkbox"/> W18"xD16" (CD1816)	.....	E2603 \$ 615				
	<input type="checkbox"/> W18"xD18" (CD1818)	.....	E2603 \$ 615				
	<input type="checkbox"/> W18"xD20" (CD1820)	.....	E2603 \$ 621				
	<input type="checkbox"/> W20"xD16" (CD2016)	.....	E2603 \$ 621				
	<input type="checkbox"/> W20"xD18" (CD2018)	.....	E2603 \$ 621				
	<input type="checkbox"/> W20"xD20" (CD2020)	.....	E2603 \$ 638				
	<b>Stimulite® Slimline Cushion</b> *Black Upholstery only  <input type="checkbox"/> Extra Sensitive (\$35 up charge) <input type="checkbox"/> Sling Style Bottom (\$52 up charge) <input type="checkbox"/> Custom Size (\$- CFP) W(    " ) x D(    " ) <input type="checkbox"/> Extra Cover (\$75 up charge)	<input type="checkbox"/> W14"xD16" (SM1416)	.....	E2603 \$ 388			
<input type="checkbox"/> W16"xD16" (SM1616)		.....	E2603 \$ 388				
<input type="checkbox"/> W16"xD18" (SM1618)		.....	E2603 \$ 388				
<input type="checkbox"/> W18"xD18" (SM1818)		.....	E2603 \$ 388				
<input type="checkbox"/> W18"xD20" (SM1820)		.....	E2603 \$ 426				
<input type="checkbox"/> W20"xD16" (SM2016)		.....	E2603 \$ 426				
<input type="checkbox"/> W20"xD18" (SM2018)		.....	E2603 \$ 426				
<input type="checkbox"/> W20"xD20" (SM2020)		.....	E2603 \$ 450				
<b>Stimulite® Corbee Pediatric</b> *Black Upholstery only <input type="checkbox"/> Extra Cover (\$75 up charge)	<input type="checkbox"/> W10"xD10" (PD1010)	.....	E2603 \$ 258				
	<input type="checkbox"/> W12"xD12" (PD1212)	.....	E2603 \$ 258				
	<input type="checkbox"/> W14"xD14" (PD1414)	.....	E2603 \$ 258				
	<input type="checkbox"/> Extra Sensitive (\$35 up charge) <input type="checkbox"/> Sling Style Bottom (\$52 up charge) <input type="checkbox"/> Custom Size W(    " ) x D(    " ) (\$- CFP)						
<b>ROHO WHEELCHAIR CUSHIONS</b>							
Choose Size	<input type="checkbox"/> 4" HIGH PROFILE® QUADTRO SELECT® CUSHION *Black Upholstery		<input type="checkbox"/> Extra Cover (\$+57) only E2622-2623 \$ 582				
	<input type="checkbox"/> W12"xD12"	<input type="checkbox"/> W12"xD13"	<input type="checkbox"/> W13"xD13"				
	<input type="checkbox"/> W15"xD16"	<input type="checkbox"/> W15"xD18"	<input type="checkbox"/> W16"xD15"				
	<input type="checkbox"/> W18"xD16"	<input type="checkbox"/> W18"xD18"	<input type="checkbox"/> W18"xD20"				
	<input type="checkbox"/> W20"xD22"	<input type="checkbox"/> W22"xD18"	<input type="checkbox"/> W22"xD20"				
Choose Size	<input type="checkbox"/> 3" MID PROFILE® QUADTRO SELECT® CUSHION *Black Upholstery only		<input type="checkbox"/> Extra Cover E2622-2623 \$ 582				
	<input type="checkbox"/> W15"xD15"	<input type="checkbox"/> W15"xD16"	<input type="checkbox"/> W16"xD16"				
	<input type="checkbox"/> W16"xD18"	<input type="checkbox"/> W16"xD18"	<input type="checkbox"/> W18"xD18"				
Choose Size	<input type="checkbox"/> 2" LOW PROFILE® QUADTRO SELECT® CUSHION *Black Upholstery only		<input type="checkbox"/> Extra Cover (\$+57) E2622-2623 \$ 582				
	<input type="checkbox"/> W12"xD12"	<input type="checkbox"/> W12"xD13"	<input type="checkbox"/> W13"xD13"				
	<input type="checkbox"/> W15"xD16"	<input type="checkbox"/> W15"xD18"	<input type="checkbox"/> W16"xD15"				
	<input type="checkbox"/> W18"xD16"	<input type="checkbox"/> W18"xD18"	<input type="checkbox"/> W18"xD20"				
	<input type="checkbox"/> W20"xD18"	<input type="checkbox"/> W20"xD16"	<input type="checkbox"/> W20"xD20"				
<b>STAR CUSHIONS</b>							
<b>Galaxy Cushion</b> *Black Upholstery only <input type="checkbox"/> W14"xD14" ( GXY 1414-2) <input type="checkbox"/> W16"xD14" ( GXY 1614-2) <input type="checkbox"/> W16"xD18" ( GXY 1618-2) <input type="checkbox"/> W18"xD18" ( GXY 1818-2) <input type="checkbox"/> W20"xD16" ( GXY 2016-2) <input type="checkbox"/> W20"xD20" ( GXY 2020-2)	<input type="checkbox"/> W14"xD16" ( GXY 1416-2) <input type="checkbox"/> W16"xD16" ( GXY 1616-2) <input type="checkbox"/> W18"xD16" ( GXY 1816-2) <input type="checkbox"/> W18"xD20" ( GXY 1820-2) <input type="checkbox"/> W20"xD18" ( GXY 2018-2)	➔	Choose Zoning Options E2624 \$ CFP				
			<input type="checkbox"/> Standard - Dual Valve				
			<input type="checkbox"/> Dual Valve - Front to Back				
			<input type="checkbox"/> Four Valve				
			<input type="checkbox"/> Simple - Single Valve				
			<input type="checkbox"/> Four Valve - Enhanced				
			<input type="checkbox"/> Four Valve - Front to Back				
<b>THE CURVE CUSHION</b> *Black Upholstery only <input type="checkbox"/> Extra Cover (\$+ 40)	<input type="checkbox"/> W10"xD10"	<input type="checkbox"/> W10"xD11"	<input type="checkbox"/> W10"xD11"	<input type="checkbox"/> W10"xD12"	<input type="checkbox"/> W11"xD12"	<input type="checkbox"/> W12"xD12"	\$ 127
	<input type="checkbox"/> W12"xD13"	<input type="checkbox"/> W12"xD14"	<input type="checkbox"/> W13"xD11"	<input type="checkbox"/> W13"xD12"	<input type="checkbox"/> W13"xD13"	<input type="checkbox"/> W13"xD14"	
	<input type="checkbox"/> W14"xD14"	<input type="checkbox"/> W14"xD15"	<input type="checkbox"/> W14"xD16"	<input type="checkbox"/> W15"xD14"	<input type="checkbox"/> W15"xD15"	<input type="checkbox"/> W15"xD16"	
	<input type="checkbox"/> W16"xD14"	<input type="checkbox"/> W16"xD15"	<input type="checkbox"/> W16"xD16"	<input type="checkbox"/> W16"xD17"	<input type="checkbox"/> W16"xD18"	<input type="checkbox"/> W17"xD16"	
	<input type="checkbox"/> W17"xD17"	<input type="checkbox"/> W17"xD18"	<input type="checkbox"/> W18"xD16"	<input type="checkbox"/> W18"xD17"	<input type="checkbox"/> W18"xD18"		

Valid from 2022 Prices & Specifications Are Subject To Change Without

**G CHAIR OPTIONS 2 / 3**

SEAT CUSHION			
<b>Exgel Kaji Cushion</b>			
<b>For Comfortable Sitting To Prevent Pressure Sores</b>			
<input type="checkbox"/> <b>Owl Regular(1.6" Thick)</b> Incontinence Cover Only	<input type="checkbox"/> W14"xD16"	.....	E2603 \$ 362
	<input type="checkbox"/> W15"xD16"	.....	E2603 \$ 362
	<input type="checkbox"/> W16"xD16"	.....	E2603 \$ 362
	<input type="checkbox"/> W18"xD16"	..... * No Custom Sizes	E2603 \$ 408
<input type="checkbox"/> <b>Owl High(3.1" Thick)</b> Incontinence Cover Only	<input type="checkbox"/> W14"xD16"	.....	E2603 \$ 437
	<input type="checkbox"/> W15"xD16"	.....	E2603 \$ 437
	<input type="checkbox"/> W16"xD16"	.....	E2603 \$ 437
	<input type="checkbox"/> W18"xD16"	.....	E2603 \$ 495
	<input type="checkbox"/> W18"xD18"	..... * No Custom Sizes	E2603 \$ 495
<input type="checkbox"/> <b>Owl Contour(4.3" Thick)</b> Incontinence Cover Only	<input type="checkbox"/> W14"xD16"	.....	E2603 \$ 454
	<input type="checkbox"/> W15"xD16"	.....	E2603 \$ 454
	<input type="checkbox"/> W16"xD16"	.....	E2603 \$ 454
	<input type="checkbox"/> W18"xD16"	.....	E2603 \$ 495
		* No Custom Sizes	
<input type="checkbox"/> <b>Owl Deep Contour(4.3" Thick)</b> <input type="checkbox"/> W14"xD16" \$ 458		* No Custom Sizes- Incontinence Cover Only	
<input type="checkbox"/> W14"xD16" \$518 <input type="checkbox"/> W15"xD16" \$518 <input type="checkbox"/> W16"xD16" \$518 <input type="checkbox"/> W18"xD16" \$558			
<input type="checkbox"/> <b>Standard Regular(1.4" Thick)</b> Easy to Use Flat Style (superior pressure redistribution)		<input type="checkbox"/> <b>For Pressure</b> E2622-2623	
<input type="checkbox"/> W12" x D12" \$368	<input type="checkbox"/> W13" x D13" \$368	<input type="checkbox"/> W14" x D14" \$368	<input type="checkbox"/> W14" x D16" \$368
<input type="checkbox"/> W16" x D17" \$368	<input type="checkbox"/> W17" x D16" \$368	<input type="checkbox"/> W17" x D17" \$368	<input type="checkbox"/> W18" x D16" \$391
<input type="checkbox"/> W18" x D19" \$440	<input type="checkbox"/> W18" x D20" \$440	<input type="checkbox"/> W19" x D19" \$440	<input type="checkbox"/> W18" x D18" \$391
		* No Custom Sizes- Incontinence Cover Only	
<input type="checkbox"/> <b>Standard High(2.6" Thick)</b> Incontinence Cover Only		..... E2622	
*Black Upholstery only			
<input type="checkbox"/> W12" x D12" \$383	<input type="checkbox"/> W13" x D13" \$ 383	<input type="checkbox"/> W14" x D14" \$383	<input type="checkbox"/> W14" x D16" \$ 383
<input type="checkbox"/> W16" x D17" \$383	<input type="checkbox"/> W17" x D16" \$383	<input type="checkbox"/> W17" x D17" \$383	<input type="checkbox"/> W18" x D16" \$460
<input type="checkbox"/> W18" x D19" \$512	<input type="checkbox"/> W18" x D20" \$512	<input type="checkbox"/> W19" x D19" \$512	<input type="checkbox"/> W18" x D18" \$460
<input type="checkbox"/> W18" x D19" \$512	<input type="checkbox"/> W18" x D20" \$512	<input type="checkbox"/> W19" x D19" \$512	<input type="checkbox"/> W18" x D19" \$512
<input type="checkbox"/> <b>Standard Anti-Thrust(2.6" Thick)</b> * No Custom Sizes Incontinence Cover Only		<input type="checkbox"/> W16 x D16 \$460 <input type="checkbox"/> W18 x D16 \$500 <input type="checkbox"/> W18 x D18 \$500	Prevents Unwanted Forward Movement of lower back and hip bone
<input type="checkbox"/> <b>Lite Regular(2.2" Thick)</b>		<input type="checkbox"/> W16" x D16" \$374 <input type="checkbox"/> W18" x D16" \$397 <input type="checkbox"/> W18" x D18" \$397	* No Custom Sizes- Incontinence Cover Only
<input type="checkbox"/> <b>Lite High(3.0" Thick)</b>		<input type="checkbox"/> W16" x D16" \$408 <input type="checkbox"/> W18" x D16" \$431 <input type="checkbox"/> W18" x D18" \$431	* No Custom Sizes- Incontinence Cover Only

Valid from 2022 Prices & Specifications Are Subject To Change Without Notice.

**H CHAIR OPTIONS 3 / 3**

**POSITIONING BACK**

**\*Note : Actual height of the backrest will increase 2" or more.**

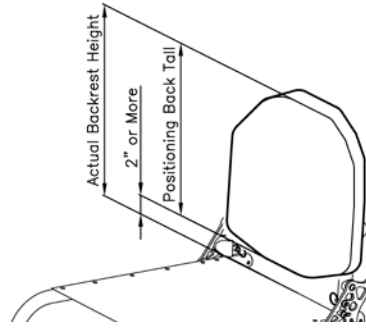

**ADI CARBON BACKREST (Support Contour-ACTIVE 2.5")** \*Not Available with Welded Side Guards

Mounting Hardware:	<input type="checkbox"/> 2 Point Pro <input type="checkbox"/> Quick Release			
Height	<input type="checkbox"/> LOW (10" Tall) *Backrest Height requires 12" or more *Available 13"-19" width	Width (    ")	<b>E2613</b>	\$ 857
	<input type="checkbox"/> Medium (13" Tall) *Backrest Height requires 15" or more *Available 13"-19" width	Width (    ")	<b>E2613</b>	\$ 937
<input type="checkbox"/> Add Privacy Flap	<input type="checkbox"/> Standard (16" Tall) *Backrest Height requires 18" or more *Available 13"-19" width	Width (    ")	<b>E2613</b>	\$1,012
<b>(\$69 up charge)</b>	<input type="checkbox"/> Custom Size (    " Tall) x (    " width) . . . . .		<b>E2613</b>	\$ CFP

**ADI ALUMINUM BACKREST (Support Contour-ACTIVE 2.5")** \*Not Available with Welded Side Guards

Mounting Hardware:	<input type="checkbox"/> 2 Point Pro <input type="checkbox"/> Quick Release			
Height	<input type="checkbox"/> LOW (10" Tall) *Backrest Height requires 12" or more *Available 10"-20" width	Width (    ")	<b>E2613</b>	\$ 702
	<input type="checkbox"/> Medium (13" Tall) *Backrest Height requires 15" or more *Available 12"-20" width	Width (    ")	<b>E2613</b>	\$ 719
	<input type="checkbox"/> Standard (16" Tall) *Backrest Height requires 18" or more *Available 14"-20" width	Width (    ")	<b>E2613</b>	\$ 736
	<input type="checkbox"/> Tall (18" Tall) *Backrest Height requires 20" or more *Available 16"-20" width	Width (    ")	<b>E2613</b>	\$ 753
<input type="checkbox"/> Add Privacy Flap	<input type="checkbox"/> X-Tall (20" Tall) *Backrest Height requires 22" or more *Available 16"-20" width	Width (    ")	<b>E2613</b>	\$ 570
<b>(\$69 up charge)</b>	<input type="checkbox"/> Custom Size (    " Tall) x (    " width) . . . . .		<b>E2613</b>	\$ CFP

**ADI ALUMINUM BACKREST (Support Contour-DEEP 4")** \*Not Available with Welded Side Guards\*Not Available with Lateral Supports

Mounting Hardware:	<input type="checkbox"/> 2 Point Pro <input type="checkbox"/> Quick Release			
Height	<input type="checkbox"/> LOW (10" Tall) *Backrest Height requires 12" or more *Available 10"-20" width	Width (    ")	<b>E2615</b>	\$ 817
	<input type="checkbox"/> Medium (13" Tall) *Backrest Height requires 15" or more *Available 12"-20" width	Width (    ")	<b>E2615</b>	\$ 834
	<input type="checkbox"/> Standard (16" Tall) *Backrest Height requires 18" or more *Available 14"-20" width	Width (    ")	<b>E2615</b>	\$ 851
	<input type="checkbox"/> Tall (18" Tall) *Backrest Height requires 20" or more *Available 16"-20" width	Width (    ")	<b>E2615</b>	\$ 868
<input type="checkbox"/> Add Privacy Flap	<input type="checkbox"/> X-Tall (20" Tall) *Backrest Height requires 22" or more *Available 16"-20" width	Width (    ")	<b>E2615</b>	\$ 886
<b>(\$69 up charge)</b>	<input type="checkbox"/> Custom Size (    " Tall) x (    " width) . . . . .		<b>E2615</b>	\$ CFP

**ADI LATERAL SUPPORTS ( Lateral Supports are compatible with only active 2.5" ADI positioning back. )**

<input type="checkbox"/> Stationary Pad	Pad Size <input type="checkbox"/> Small (3" H x 3" D) <input type="checkbox"/> Medium(3" H x 4" D) <input type="checkbox"/> Large(4.5" H x 4.5" D) <input type="checkbox"/> Large(4" H x 6" D)			
	<input type="checkbox"/> Pair . . . . .			\$ 368
	<input type="checkbox"/> Left side only or <input type="checkbox"/> Right side only . . . . .			\$ 184
<input type="checkbox"/> Swing-Out	Pad Size <input type="checkbox"/> Small (3" H x 3" D) <input type="checkbox"/> Medium(3" H x 4" D) <input type="checkbox"/> Large(4.5" H x 4.5" D) <input type="checkbox"/> Large(4" H x 6" D)			
	<input type="checkbox"/> Pair . . . . .			\$ 598
	<input type="checkbox"/> Left side only or <input type="checkbox"/> Right side only . . . . .			\$ 299

**OTHER**

<input type="checkbox"/> ADI Transfer Board	<input type="checkbox"/> 21" (ADV21) <input type="checkbox"/> 24" (ADV24) <input type="checkbox"/> 29" . . . . . (ADV29)			\$ 71
<input type="checkbox"/> ADI Push and Transfer Gloves	Leather (one size fits) . . . . .			\$ 69
<input type="checkbox"/> ADI Carbon Solid Seat	(Wide: 18" Max, Depth: 20" ) ✘ ONLY AVAILABLE WITH COLOURS NON-REMOVABLE SIDE GUARDS			\$ 719

**VARILITE® Seating Systems Available**

Please visit for all options. [www.varilite.com](http://www.varilite.com)    CFP

**NOTE**