

**LITTLE DIPPER
GROWTH PROGRAM**

ORDER FORM
Ver. 2.0 Rev-072513

DEALER			COLOURS INFORMATION For Office Use Only		
Dealer:			Order Date:		S/N:
Account:		P.O.#:	RTS		
Ordered By:			RTS:		Phone:
Address:			Email:		
City:		State:	Zip:		SHIP TO
Phone:		Fax:		Name:	
Email:			Ship Via:		
Customer Name:			Address:		
Customer Weight:			City:		State:
			Phone:		Zip:
			Fax:		
CHAIR INFORMATION			PRICE		
LITTLE DIPPER K0009 Max. Capacity 250Lbs			GROWTH PROGRAM		\$ 968
Main Frame : ZK55 & ZK60 High Grade A7000 Series Aluminum			Swap Over Parts		\$
Main Frame : Lifetime Warranty *See warranty policy			Total Section A		\$
			Total Section B		\$
			ORDER GRAND TOTAL		\$

This Growth Program was implemented by Colours to help assure that our youngest clients will continue to enjoy the maximum benefits from a custom fitted rigid wheelchair. All Colours products are designed to give the user maximum freedom in movement, and we know how especially important this is during the early years. The kit comes with all the parts needed to increase the dimensions of the wheelchair, including a new frame.



To order your Growth Kit, please provide us with the following information:

Current Frame **SERIAL#**: _____

SWAP OVER PARTS FROM CURRENT CHAIR

<input type="checkbox"/> Swap Over by Colours *Flat Fee Labor Charge	\$ 200 + Shipping
--	----------------------

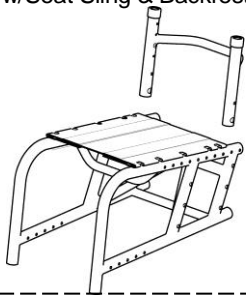
A GROWTH PROGRAM

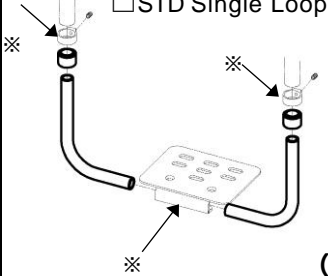
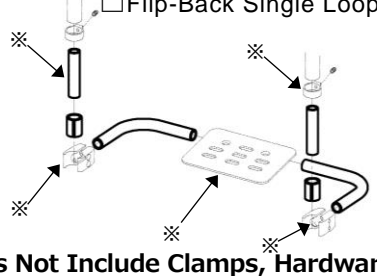
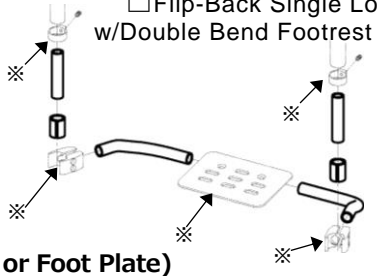
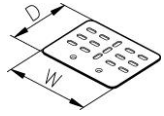
<p>✳️Growth Kit Includes :</p> <ul style="list-style-type: none"> ● Main Frame w/Seat Sling & Backrest Tube 		<ul style="list-style-type: none"> ● Backrest Upholstery <p>Choose your backrest style ↓</p> 										
<ul style="list-style-type: none"> <input type="checkbox"/> STD Adj. Height (Black Color) <input type="checkbox"/> STD Adj. Height w/Integrated push handle (Black Color) <input type="checkbox"/> Adjustable Tension Backrest (Black Color) <input type="checkbox"/> Adjustable Tension Backrest (Black Color) w/Integrated push handle (Black Color) 			\$ STD \$ STD \$ 135 \$ 135									
<ul style="list-style-type: none"> <input type="checkbox"/> Custom Colored <input type="checkbox"/> Red <input type="checkbox"/> Black (\$60 up charge) <input type="checkbox"/> Fabrics for Fun - (#) (\$95 up charge) <input type="checkbox"/> Leather Trim (\$77 up charge) 												
<ul style="list-style-type: none"> ● Footrest Loop For New Chair Width 		<p>Choose your current footplate style ↓</p> <ul style="list-style-type: none"> <input type="checkbox"/> STD Single Loop <input type="checkbox"/> Flip-Back Single Loop <input type="checkbox"/> Flip-Back Single Loop w/Double Bend Footrest Loop 										
												
		<p>(✳️Does Not Include Clamps, Hardware, or Foot Plate)</p>										
<ul style="list-style-type: none"> <input type="checkbox"/> w/ New Foot Plate 		<ul style="list-style-type: none"> <input type="checkbox"/> W6.5"xD5" <input type="checkbox"/> W8.5"xD6.5" <input type="checkbox"/> W11.0"xD6.5" 		\$ 50								
<table border="1"> <thead> <tr> <th>Your Seat Width</th> <th>Foot Plate Size</th> </tr> </thead> <tbody> <tr> <td>10"-12"</td> <td>W6.5"xD5"</td> </tr> <tr> <td>13"-15"</td> <td>W8.5"xD6.5"</td> </tr> <tr> <td>16"-</td> <td>W11"xD6.5"</td> </tr> </tbody> </table>		Your Seat Width	Foot Plate Size	10"-12"	W6.5"xD5"	13"-15"	W8.5"xD6.5"	16"-	W11"xD6.5"			
Your Seat Width	Foot Plate Size											
10"-12"	W6.5"xD5"											
13"-15"	W8.5"xD6.5"											
16"-	W11"xD6.5"											
Total Section A			\$									

B FRAME COLORS & MEASUREMENT 1/2

Caster Barrel to Floor Height

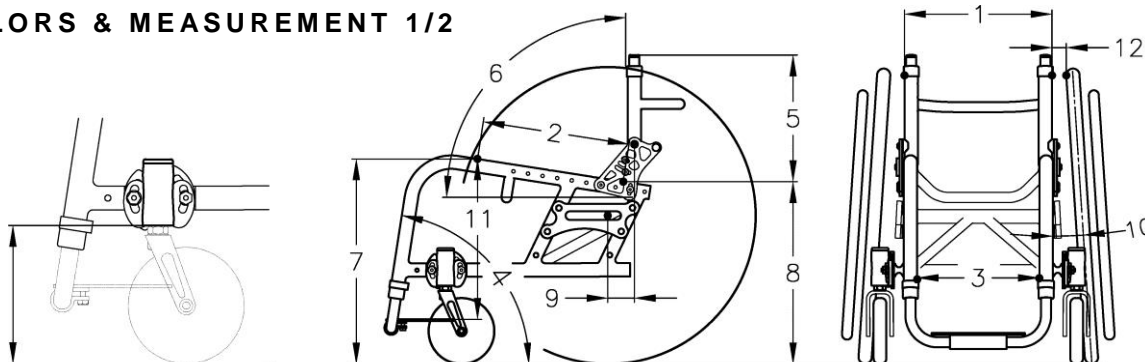

FRAME COLORS		
Powder-Coated	<input type="checkbox"/> Gloss Black	<input type="checkbox"/> Twilight Flake
	<input type="checkbox"/> Candy Blue	<input type="checkbox"/> Candy Purple
	<input type="checkbox"/> Matte Gray	<input type="checkbox"/> Matte Purple
	<input type="checkbox"/> Neon Red	<input type="checkbox"/> Neon Green
	<input type="checkbox"/> Copper	<input type="checkbox"/> Granny Sparkle Green
	<input type="checkbox"/> Yellow	<input type="checkbox"/> Candy Green
	<input type="checkbox"/> Matte Blue	<input type="checkbox"/> Orange Sparkle
	<input type="checkbox"/> Sparkle Sky Blue	<input type="checkbox"/> Vermilion
	<input type="checkbox"/> Magenta	<input type="checkbox"/> Fire Engine Red
	<input type="checkbox"/> Candy Red	<input type="checkbox"/> Candy Raspberry
	<input type="checkbox"/> Matte Green	<input type="checkbox"/> Gun Smoke Silver
	<input type="checkbox"/> Mellon Yellow	<input type="checkbox"/> Reed Green
	<input type="checkbox"/> White	<input type="checkbox"/> Cobalt Blue
	<input type="checkbox"/> Matte Red	<input type="checkbox"/> Pigeon Blue
	<input type="checkbox"/> Blue Lilac	\$ STD
Special Colors	<input type="checkbox"/> Polished	\$ 800
	<input type="checkbox"/> 24 karat Gold	\$ CFP
Custom Parts Color	Including : Backrest, *Foot Plate, *Forks & Knurl Nuts *w/New Parts Only	<input type="checkbox"/> Powder Coated ()
		<input type="checkbox"/> Polished
		\$ 125
		\$ 250

1. SEAT WIDTH	<input type="checkbox"/> 10" <input type="checkbox"/> 11" <input type="checkbox"/> 12" <input type="checkbox"/> 13" <input type="checkbox"/> 14" <input type="checkbox"/> 15"	\$ STD
----------------------	---	--------

2. SEAT DEPTH * Only Choose One Option	Depth Adj. Frame Only	<input type="checkbox"/> Short Frame (11" Depth) Set at <input type="checkbox"/> 8" <input type="checkbox"/> 9" <input type="checkbox"/> 10" <input type="checkbox"/> 11"	\$ STD
		<input type="checkbox"/> STD Frame (14" Depth) Set at <input type="checkbox"/> 10" <input type="checkbox"/> 11" <input type="checkbox"/> 12" <input type="checkbox"/> 13" <input type="checkbox"/> 14" ...	\$ STD

Positioning Frame Add (")

SEAT DEPTH

3. FOOTREST WIDTH	<input type="checkbox"/> STD (Seat Width Minus 2", No Taper Frame)	\$ STD
	<input type="checkbox"/> Custom (")	\$ NCO

4. FRAME ANGLE	<input type="checkbox"/> 75° <input type="checkbox"/> 80° <input type="checkbox"/> 85° <input type="checkbox"/> 90° to the ground	\$ STD
	<input type="checkbox"/> Custom (°) to the ground	\$ NCO

5. BACKREST HEIGHT	<input type="checkbox"/> Current Backrest Height (")	\$ STD												
	<input type="checkbox"/> Change Backrest Height	\$ 30												
	<table border="0"> <tr> <td></td> <td>Adj. Range</td> <td></td> <td>Adj. Range</td> <td></td> <td>Adj. Range</td> </tr> <tr> <td><input type="checkbox"/> 8"</td> <td><input type="checkbox"/> 9" <input type="checkbox"/> 10" <input type="checkbox"/> 11"</td> <td><input type="checkbox"/> 12"</td> <td><input type="checkbox"/> 13" <input type="checkbox"/> 14" <input type="checkbox"/> 15"</td> <td><input type="checkbox"/> 16"</td> <td><input type="checkbox"/> 17" <input type="checkbox"/> 18"</td> </tr> </table>		Adj. Range		Adj. Range		Adj. Range	<input type="checkbox"/> 8"	<input type="checkbox"/> 9" <input type="checkbox"/> 10" <input type="checkbox"/> 11"	<input type="checkbox"/> 12"	<input type="checkbox"/> 13" <input type="checkbox"/> 14" <input type="checkbox"/> 15"	<input type="checkbox"/> 16"	<input type="checkbox"/> 17" <input type="checkbox"/> 18"	
	Adj. Range		Adj. Range		Adj. Range									
<input type="checkbox"/> 8"	<input type="checkbox"/> 9" <input type="checkbox"/> 10" <input type="checkbox"/> 11"	<input type="checkbox"/> 12"	<input type="checkbox"/> 13" <input type="checkbox"/> 14" <input type="checkbox"/> 15"	<input type="checkbox"/> 16"	<input type="checkbox"/> 17" <input type="checkbox"/> 18"									

6. BACKREST ANGLE	Set at (°) to the ground *STD 90°	\$ STD
--------------------------	---	--------

7. FRONT SEAT HEIGHT ★ Please give us your current casters information	Current Caster Barrel to Floor Height (")		\$ STD
	Current Caster Size (")		
	Current Caster Forks <input type="checkbox"/> STD <input type="checkbox"/> Springs <input type="checkbox"/> Frog Legs		

<input type="checkbox"/> Current Front Seat Height (")	\$ STD
or	
<input type="checkbox"/> New Front Seat Height w/New Caster Stems or STD Forks	\$ 120
<input type="checkbox"/> 14.5" <input type="checkbox"/> 15.0" <input type="checkbox"/> 15.5" <input type="checkbox"/> 16.0" <input type="checkbox"/> 16.5" <input type="checkbox"/> 17.0" <input type="checkbox"/> 17.5" <input type="checkbox"/> 18.0" <input type="checkbox"/> 18.5"	

Front Seat Height Ranges	Front Seat Height								
	14.5"	15.0"	15.5"	16.0"	16.5"	17.0"	17.5"	18.0"	18.5"
3" Caster & STD Forks	<input type="checkbox"/> *	<input type="checkbox"/> *	<input type="checkbox"/>	<input type="checkbox"/>	<input type="checkbox"/>	<input type="checkbox"/>	<input type="checkbox"/>	<input type="checkbox"/>	<input type="checkbox"/>
3" Caster & Springs			<input type="checkbox"/>	<input type="checkbox"/>	<input type="checkbox"/>	<input type="checkbox"/>	<input type="checkbox"/>	<input type="checkbox"/>	<input type="checkbox"/>
3" Caster & Frog Legs				<input type="checkbox"/> *	<input type="checkbox"/> *	<input type="checkbox"/> *	<input type="checkbox"/> *	<input type="checkbox"/> *	<input type="checkbox"/> *
4" Caster & STD Forks			<input type="checkbox"/>	<input type="checkbox"/>	<input type="checkbox"/>	<input type="checkbox"/>	<input type="checkbox"/>	<input type="checkbox"/>	<input type="checkbox"/>
4" Caster & Springs				<input type="checkbox"/>	<input type="checkbox"/>	<input type="checkbox"/>	<input type="checkbox"/>	<input type="checkbox"/>	<input type="checkbox"/>
4" Caster & Frog Legs				<input type="checkbox"/> *	<input type="checkbox"/> *	<input type="checkbox"/> *	<input type="checkbox"/> *	<input type="checkbox"/> *	<input type="checkbox"/> *
5" Caster & STD Forks					<input type="checkbox"/> *	<input type="checkbox"/>	<input type="checkbox"/>	<input type="checkbox"/>	<input type="checkbox"/> *
5" Caster & Springs					<input type="checkbox"/> *	<input type="checkbox"/> *	<input type="checkbox"/> *	<input type="checkbox"/> *	<input type="checkbox"/> *
5" Caster & Frog Legs					<input type="checkbox"/> *	<input type="checkbox"/> *	<input type="checkbox"/> *	<input type="checkbox"/> *	<input type="checkbox"/> *

*=Not Available with Quick Release Caster Axle.

The front seat heights are impacted by the size of your front caster.

B FRAME COLORS & MEASUREMENT 2/2

8. REAR SEAT HEIGHT	★Please give us your <input type="checkbox"/> 20"x1"(451) <input type="checkbox"/> 20"x1 3/8"(451) current tires information <input type="checkbox"/> 22"x1"(501) <input type="checkbox"/> 22"x1 3/8"(501) <input type="checkbox"/> ()																																																																																																																																																			
	↓ <input type="checkbox"/> Current Rear Seat Height (")		\$ STD																																																																																																																																																	
	<input type="checkbox"/> New Rear Seat Height <input type="checkbox"/> 12.5" <input type="checkbox"/> 13.0" <input type="checkbox"/> 13.5" <input type="checkbox"/> 14.0" <input type="checkbox"/> 14.5" <input type="checkbox"/> 15.0" <input type="checkbox"/> 15.5" <input type="checkbox"/> 16.0" <input type="checkbox"/> 16.5"		\$ NCO																																																																																																																																																	
	Rear Seat Height Ranges The rear seat heights are impacted by the size of your Tires.	<table border="1" style="width:100%; border-collapse: collapse;"> <thead> <tr> <th style="width:30%;">Rear Tire Size</th> <th style="width:70%;">Rear Seat Height</th> </tr> </thead> <tbody> <tr> <td>20"x1"(451)</td> <td>12.5"- 15.0"</td> </tr> <tr> <td>20"x1 3/8"(451)</td> <td>13.0"- 15.5"</td> </tr> <tr> <td>22"x1"(501)</td> <td>13.5"- 16.0"</td> </tr> <tr> <td>22"x1 3/8"(501)</td> <td>14.0"- 16.5"</td> </tr> </tbody> </table>	Rear Tire Size	Rear Seat Height	20"x1"(451)	12.5"- 15.0"	20"x1 3/8"(451)	13.0"- 15.5"	22"x1"(501)	13.5"- 16.0"	22"x1 3/8"(501)	14.0"- 16.5"																																																																																																																																								
Rear Tire Size	Rear Seat Height																																																																																																																																																			
20"x1"(451)	12.5"- 15.0"																																																																																																																																																			
20"x1 3/8"(451)	13.0"- 15.5"																																																																																																																																																			
22"x1"(501)	13.5"- 16.0"																																																																																																																																																			
22"x1 3/8"(501)	14.0"- 16.5"																																																																																																																																																			
9. CENTER OF GRAVITY	<input type="checkbox"/> -1.5" <input type="checkbox"/> -1.0" <input type="checkbox"/> -0.5" <input type="checkbox"/> 0" <input type="checkbox"/> 0.5" <input type="checkbox"/> 1.0" <input type="checkbox"/> 1.5" <input type="checkbox"/> 2.0" <input type="checkbox"/> 2.5" <input type="checkbox"/> 3.0" <input type="checkbox"/> 3.5" <input type="checkbox"/> 4.0" ...		\$ STD																																																																																																																																																	
Center of Gravity Ranges ☆=Not Available 5" Caster. ★=Not Available 22" Wheel.	<table border="1" style="width:100%; border-collapse: collapse;"> <thead> <tr> <th rowspan="2" style="width:10%;">Seat Depth</th> <th colspan="13" style="text-align: center;">Your Center of Gravity</th> </tr> <tr> <th style="width:5%;">-1.5"</th> <th style="width:5%;">-1.0"</th> <th style="width:5%;">-0.5"</th> <th style="width:5%;">0"</th> <th style="width:5%;">0.5"</th> <th style="width:5%;">1.0"</th> <th style="width:5%;">1.5"</th> <th style="width:5%;">2.0"</th> <th style="width:5%;">2.5"</th> <th style="width:5%;">3.0"</th> <th style="width:5%;">3.5"</th> <th style="width:5%;">4.0"</th> </tr> </thead> <tbody> <tr> <td rowspan="4" style="writing-mode: vertical-rl; transform: rotate(180deg);">Short Frame</td> <td>8"</td> <td></td> <td></td> <td><input type="checkbox"/></td> <td><input type="checkbox"/></td> <td><input type="checkbox"/>☆★</td> <td><input type="checkbox"/>☆★</td> <td></td> <td></td> <td></td> <td></td> <td></td> <td></td> </tr> <tr> <td>9"</td> <td></td> <td></td> <td></td> <td></td> <td><input type="checkbox"/></td> <td><input type="checkbox"/></td> <td><input type="checkbox"/>☆★</td> <td><input type="checkbox"/>☆★</td> <td></td> <td></td> <td></td> <td></td> </tr> <tr> <td>10"</td> <td></td> <td></td> <td></td> <td></td> <td></td> <td></td> <td><input type="checkbox"/></td> <td><input type="checkbox"/></td> <td><input type="checkbox"/>☆★</td> <td><input type="checkbox"/>☆★</td> <td></td> <td></td> </tr> <tr> <td>11"</td> <td></td> <td></td> <td></td> <td></td> <td></td> <td></td> <td></td> <td></td> <td><input type="checkbox"/></td> <td><input type="checkbox"/></td> <td><input type="checkbox"/>☆★</td> <td><input type="checkbox"/>☆★</td> </tr> <tr> <td rowspan="4" style="writing-mode: vertical-rl; transform: rotate(180deg);">STD Frame</td> <td>10"</td> <td><input type="checkbox"/></td> <td><input type="checkbox"/></td> <td><input type="checkbox"/></td> <td><input type="checkbox"/>☆</td> <td></td> <td></td> <td></td> <td></td> <td></td> <td></td> <td></td> <td></td> </tr> <tr> <td>11"</td> <td></td> <td></td> <td><input type="checkbox"/></td> <td><input type="checkbox"/></td> <td><input type="checkbox"/></td> <td><input type="checkbox"/>☆</td> <td></td> <td></td> <td></td> <td></td> <td></td> <td></td> </tr> <tr> <td>12"</td> <td></td> <td></td> <td></td> <td></td> <td><input type="checkbox"/></td> <td><input type="checkbox"/></td> <td><input type="checkbox"/></td> <td><input type="checkbox"/>☆</td> <td></td> <td></td> <td></td> <td></td> </tr> <tr> <td>13"</td> <td></td> <td></td> <td></td> <td></td> <td></td> <td></td> <td><input type="checkbox"/></td> <td><input type="checkbox"/></td> <td><input type="checkbox"/></td> <td><input type="checkbox"/>☆</td> <td></td> <td></td> </tr> <tr> <td></td> <td>14"</td> <td></td> <td></td> <td></td> <td></td> <td></td> <td></td> <td></td> <td><input type="checkbox"/></td> <td><input type="checkbox"/></td> <td><input type="checkbox"/></td> <td><input type="checkbox"/>☆</td> </tr> </tbody> </table>		Seat Depth	Your Center of Gravity													-1.5"	-1.0"	-0.5"	0"	0.5"	1.0"	1.5"	2.0"	2.5"	3.0"	3.5"	4.0"	Short Frame	8"			<input type="checkbox"/>	<input type="checkbox"/>	<input type="checkbox"/> ☆★	<input type="checkbox"/> ☆★							9"					<input type="checkbox"/>	<input type="checkbox"/>	<input type="checkbox"/> ☆★	<input type="checkbox"/> ☆★					10"							<input type="checkbox"/>	<input type="checkbox"/>	<input type="checkbox"/> ☆★	<input type="checkbox"/> ☆★			11"									<input type="checkbox"/>	<input type="checkbox"/>	<input type="checkbox"/> ☆★	<input type="checkbox"/> ☆★	STD Frame	10"	<input type="checkbox"/>	<input type="checkbox"/>	<input type="checkbox"/>	<input type="checkbox"/> ☆									11"			<input type="checkbox"/>	<input type="checkbox"/>	<input type="checkbox"/>	<input type="checkbox"/> ☆							12"					<input type="checkbox"/>	<input type="checkbox"/>	<input type="checkbox"/>	<input type="checkbox"/> ☆					13"							<input type="checkbox"/>	<input type="checkbox"/>	<input type="checkbox"/>	<input type="checkbox"/> ☆				14"								<input type="checkbox"/>	<input type="checkbox"/>	<input type="checkbox"/>	<input type="checkbox"/> ☆	
Seat Depth	Your Center of Gravity																																																																																																																																																			
	-1.5"	-1.0"	-0.5"	0"	0.5"	1.0"	1.5"	2.0"	2.5"	3.0"	3.5"	4.0"																																																																																																																																								
Short Frame	8"			<input type="checkbox"/>	<input type="checkbox"/>	<input type="checkbox"/> ☆★	<input type="checkbox"/> ☆★																																																																																																																																													
	9"					<input type="checkbox"/>	<input type="checkbox"/>	<input type="checkbox"/> ☆★	<input type="checkbox"/> ☆★																																																																																																																																											
	10"							<input type="checkbox"/>	<input type="checkbox"/>	<input type="checkbox"/> ☆★	<input type="checkbox"/> ☆★																																																																																																																																									
	11"									<input type="checkbox"/>	<input type="checkbox"/>	<input type="checkbox"/> ☆★	<input type="checkbox"/> ☆★																																																																																																																																							
STD Frame	10"	<input type="checkbox"/>	<input type="checkbox"/>	<input type="checkbox"/>	<input type="checkbox"/> ☆																																																																																																																																															
	11"			<input type="checkbox"/>	<input type="checkbox"/>	<input type="checkbox"/>	<input type="checkbox"/> ☆																																																																																																																																													
	12"					<input type="checkbox"/>	<input type="checkbox"/>	<input type="checkbox"/>	<input type="checkbox"/> ☆																																																																																																																																											
	13"							<input type="checkbox"/>	<input type="checkbox"/>	<input type="checkbox"/>	<input type="checkbox"/> ☆																																																																																																																																									
	14"								<input type="checkbox"/>	<input type="checkbox"/>	<input type="checkbox"/>	<input type="checkbox"/> ☆																																																																																																																																								
10. CAMBER ANGLE	<input type="checkbox"/> 2° <input type="checkbox"/> 4° <input type="checkbox"/> 6° <input type="checkbox"/> 8°		\$ STD																																																																																																																																																	
11. FRONT OF SEAT SLING TO FOOTREST	<input type="checkbox"/> 12.5" <input type="checkbox"/> 13.0" <input type="checkbox"/> 13.5" <input type="checkbox"/> 14.0" <input type="checkbox"/> 14.5" <input type="checkbox"/> 15.0" <input type="checkbox"/> 15.5" <input type="checkbox"/> 16.0" <input type="checkbox"/> 16.5" <input type="checkbox"/> 17.0"..... *Measurement must be 2.0" shorter than your Front Seat Height		\$ STD																																																																																																																																																	
HIGH MOUNT	<input type="checkbox"/> w/Current Risers or Clamps <input type="checkbox"/> w/New Risers or Clamps <input type="checkbox"/> 6.5" <input type="checkbox"/> 7.0" <input type="checkbox"/> 7.5" <input type="checkbox"/> 8.0" <input type="checkbox"/> 8.5" <input type="checkbox"/> 9.0" <input type="checkbox"/> 9.5" <input type="checkbox"/> 10.0" <input type="checkbox"/> 10.5" <input type="checkbox"/> 11.0" <input type="checkbox"/> 11.5" <input type="checkbox"/> 12.0"		\$ STD \$ NCO																																																																																																																																																	
12. INSIDE WHEEL CLEARANCE	<input type="checkbox"/> 3/4" * <input type="checkbox"/> 1" * <input type="checkbox"/> 1 1/4" <input type="checkbox"/> 1 1/2" <input type="checkbox"/> 1 3/4" <input type="checkbox"/> 2" *3/4" and 1" Inside wheel clearance not available with 2 degree camber. *3/4" and 1" Inside wheel clearance not available with Armrest. *3/4" and 1" Inside wheel clearance not available with Bite Hub Locks		\$ STD																																																																																																																																																	
Sub Total Section B 1/2 \$ Sub Total Section B 2/2 \$ Total Section B \$																																																																																																																																																				

NOTE	
-------------	--